

Wear Resistant Parts

2026

- Agricultural
- Vegetation Management
- Grass Care



Ph: 07 3881 3464

sales@asproducts.com.au

www.asproducts.com.au

SIMPLE TO ORDER

Phone: 07 3881 3464

Email: sales@asproducts.com.au

Website: www.asproducts.com.au

Feel free to discuss your requirements with our sales team on the above numbers or via email sales@asproducts.com.au



PAYMENT OPTIONS:

We provide most payment options including:

Mastercard, Visa, EFT & 30 day trading accounts for approved repeat customers.

NATIONAL DISTRIBUTION

Rapid dispatch & competitive freight rates Australia wide. Ask us for the best freight options for your requirements.



SERVICE YOU CAN COUNT ON NO MATTER WHERE YOU ARE IN AUSTRALIA!
Fast, efficient dispatch. Experienced, friendly and service oriented sales team.

ASP ACCOUNT HOLDERS - WEBSITE ORDERS

Please email sales@asproducts.com.au or call 07 3881 3464 to request your secure website account login details. Place orders, check current pricing & stock, review previous orders etc.

www.asproducts.com.au

ASP has the sole Australian distributorship rights for two of Europe's leading specialist wear resistant parts manufacturers.

Our suppliers utilize world class manufacturing techniques and source the finest raw materials to ensure you get maximum wear life and value for money!



LA PIÑA
WORK WELL DONE





CONTENTS

Ripper Points, Tines, Shanks, Clamps etc	Pages 4 - 9
Rotary Hoe & Power Harrow Blades	Pages 10 - 14
Speed Tiller Discs	Pages 15
Discs & Coulters	Pages 15 - 18
Slasher Blades	Pages 19 - 34
Mulcher Flails & Hammers	Pages 35 - 50
Stump Grinder & Fixed Mulcher Teeth	Page 51
Push Mower & Finishing Mower Blades	Pages 52 - 54
Turf Cutter / Harvester Blades	Page 55
Ride On Mower Blades	Pages 56 - 84
Edger Blades	Page 85
Trimmer Line & Trimmer Heads	Pages 86 - 88
Litter Pickup Tools	Page 88

QUALITY PARTS, AFFORDABLE PRICES!

Ripper Points & Sweeps

Reversible Point - Coil Tine

- AS-01317 40mm x 12mm x 300mm (31SL-1)
- AS-01319 50mm x 16mm x 310mm (31SL-3)
- AS-01320 65mm x 16mm x 310mm (31SL-4)

7/16 Bolt holes at 51mm centres
ASP-09024 Bolt & Nut



Reversible Point - Suit Rear Mount Coil Tines

- AS-800006 40mm x 16mm x 270mm

14mm Bolt holes at 45mm centres
ASP-09023 Bolt & Nut



Reversible Point

- AS-01329 65mm x 13mm x 380mm

1/2" Bolt holes at 57mm centres
ASP-09023 Bolt & Nut



Universal Ripper Point

- AS-01349 62.5mm x 20mm x 300mm
- 4 x 1/2" Bolt holes / slots to suit between 51mm to 112mm centres - ASP-09023 Bolt & Nut

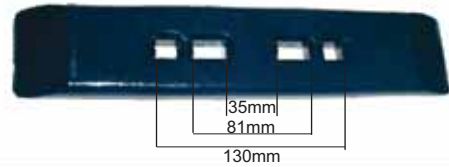

Feed Down Point

- AS-01335 Short style (314H) 43cm long
- AS-01336 Long style (315H) 58cm long

2" wide x 1/2" thick Point to suit Yeoman, Napier etc

AS-09247 Clamp & Screw



North American Chisel Plough Point -

- AS-01322 55mm x 15mm x 400mm
- 13.5mm Bolt holes at 45 - 65mm centres
ASP-09023 Bolt & Nut



Sweeps - suit Coil Tines

7/16" Bolt holes at 45mm to 51mm centers

- AS-5305H 5 Inch x 6mm
- AS-5306H 6 Inch x 6mm
- AS-5308H 8 Inch x 6mm
- AS-53010H 10 Inch x 6mm
- AS-53012H 12 Inch x 6mm

TUNGSTEN HARD FACED SWEEPS
Use ASP-09024 Bolt & Nut



Reversible Point - Trashworker

- AS-01323 50mm x 16mm x 400mm
 - AS-01323-20 50mm x 20mm x 400mm
- 2 x 14.5mm Bolt holes at 75mm centres
Suits Shearer, Econodraft, Howard etc
Reference 31SH, RC00350-16, 31SHH (20mm) **NEW**

ASP-09426 Bolt & Nut (9/16" x 2 1/4")
ASP-09429 Bolt & Nut (9/16" x 2 3/4")



Scarifier & Harvester Point

- AS-05230 180mm x 45mm wide
 - AS-05230H **HARD FACED**
- Knock on cast point
OEM Ref 6Y5230 & 2D5572

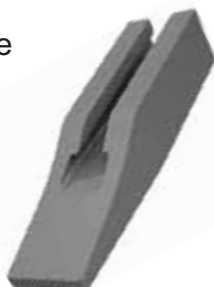

Alabama Sweeps

- ASP-58118-8 18"
- ASP-58120-8 20"
- ASP-58122-8 22"
- ASP-58124-8 24"

Spanish BORON 8mm Thick Sweeps, 2 x 1/2" Bolt Holes @ 56mm centres suit Friction Trip. Use ASP-09370 1/2" X 3" Bolt & Nut



Coil Tines & S Tines

3 x 1" Shanks & Friction Trips

AR-01537 shank 75 x 25 x 785mm
Bull nose leading edge for better trash flow. Heat Treated. Suits Friction Trip assemblies.



AR-01539 Friction Trip
AR-06370 Hardware kit



Use with ASP Alabama Sweeps. Available in:
18", 20", 22" & 24"

Coil Tine - Front

AR-01480 25mm Sq Left Hand
AR-01481 25mm Sq Right Hand

AR-01468 32mm Sq Left Hand
AR-01469 32mm Sq Right Hand

Use AS-01317 / 19 / 20 Points or AS-53 Sweeps

'A' Dimension:
25mm Tines are 580mm
32mm Tines are 680mm

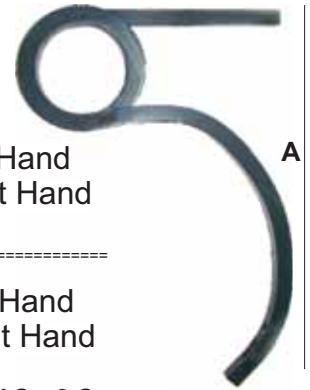

Coil Tine - Vertical

AR-01488 25mm Sq Left Hand
AR-01489 25mm Sq Right Hand

AR-01476 32mm Sq Left Hand
AR-01477 32mm Sq Right Hand

Use AS-01317 / 19 / 20 Points or AS-53 Sweep

'A' Dimension:
25mm Tines are 780mm
32mm Tines are 930mm



Coil Tine - Rear Mount

AR-Q30SVVDX L/Hand 30mm Square
AR-Q30SVVSX R/Hand 30mm Square

AR-Q25SVVDX L/Hand 25mm Square
AR-Q25SVVSX R/Hand 25mm Square

Use only **AS-800006**
Reversible Point
(14mm holes @ 45mm centres)
270mm x 40mm x 16mm
(Use ASP-09023 Bolt)
Not suitable for ASP Sweeps

Note: These are different to Agpoint etc

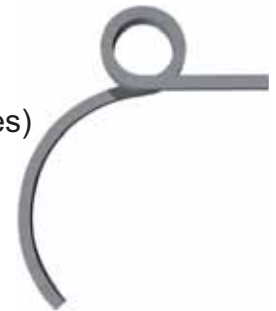

H/Duty S Tine - 70mm x 12mm

AR-F70SVV S Tine
AR-AF7012/60 Clamp 60mm Bar
AR-AF7012/65 Clamp 65mm Bar

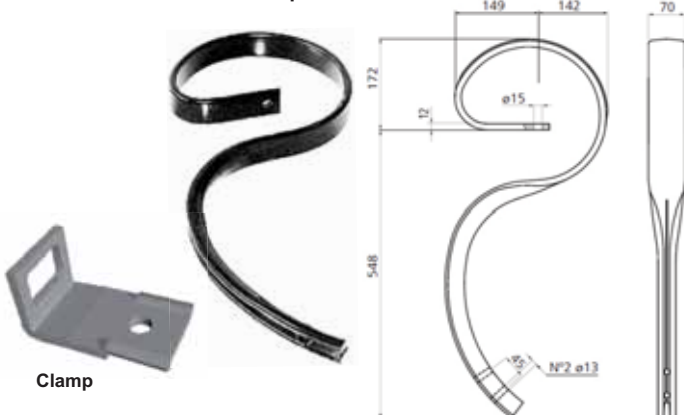

Points to suit 70mm x 12mm S Tine

AR-550299 Reversible Point
AR-550301 180mm Sweep
AR-550308 Bolt & Nut M10x55

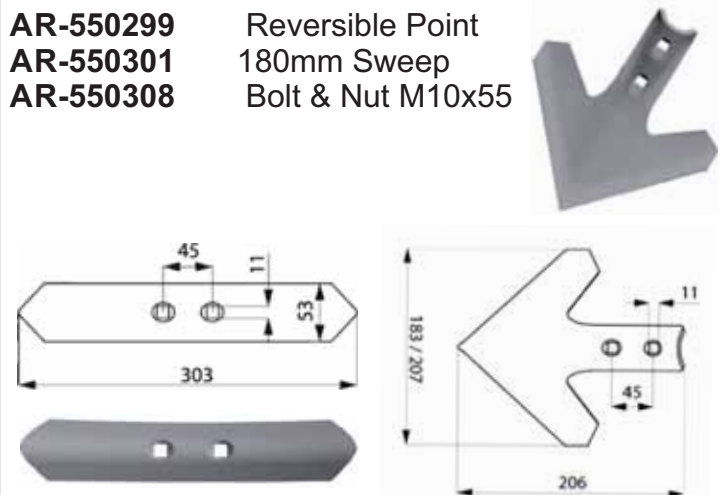

S Tines, Tines & Shanks

S Tine 45mm x 12mm

AR-F45SVV S Tine

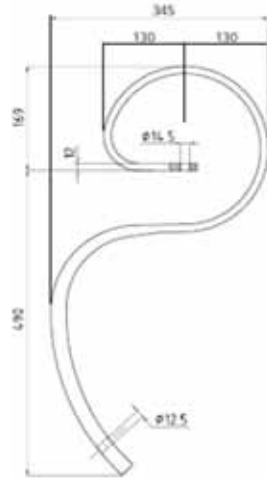

Points & Sweeps to suit 45mm x 12mm S Tines

- AR-550027 4" Sweep
- AR-550028 6" Sweep
- AR-550067 Reversible Point 255 x 55 x 6mm
- AR-550034 Reversible Point 210 x 40 x 6mm
- AR-550102 Reversible Point 210 x 40 x 8mm
- AR-AF4512/50 Clamp 50mm Bar
- AR-AF4512/65 Clamp 65mm Bar
- AR-VF4512 Bolt & Nut



S Tine 32mm x 12mm

AR-F12SVV S Tine

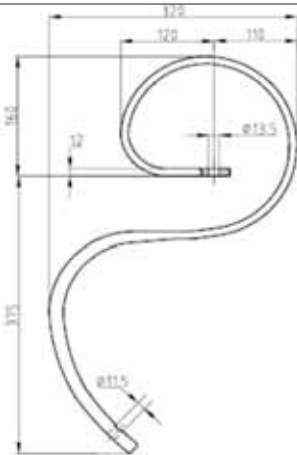

Points & Sweeps to suit 32mm x 12mm S Tines

- AR-550027 4" Sweep
- AR-550028 6" Sweep
- AR-550034 Reversible Point 210 x 40 x 6mm
- AR-550102 Reversible Point 210 x 40 x 8mm
- AR-AF3212/16 Clamp 50mm x 16mm Bar
- AR-AF3212/50 Clamp 50mm x 50mm Bar
- AR-VF4512 Bolt & Nut M10 x 45mm



Rigid Tine

AR-01107 32mm Square x 785mm

2 x 7/16" Bolt holes at 46 to 53mm centres

Use AS-01317, AS-01319 or AS-01320 Points & AS-53.. Sweeps



Cultivator Shank

AR-01512
50mm x 25mm
x 530mm

Use AS-01329 Point

Suits Yeoman, Berends,
Waratah &
Jarrett style cultivators.

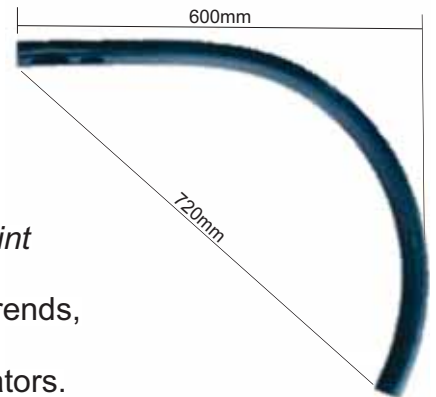

Cast Aerator "Shattertine"

- CI-08862 Left Hand
- CI-08863 Right Hand
- CI-08862H **HARD FACED**
- CI-08863H **HARD FACED**
- CIA-09362 Bolt & Nut

(13.5mm holes @ 46mm centres,
9" long from centre of top hole)
Same design as the AerWay Shattertine.
To fit Berends, Agrifarm, Agrivator & Leda etc
Suits 3" (75mm) Rotor / drum



Beet Knife Tine

AR-01536 32mm Square
Beet Knife Tine, 32mm square x 740mm long with
3 x 3/8" holes at 32mm - 57mm centres



Weeder Rake & Cultivator Tines

Multi Weeder Rake Tine 16mm

AR-01383 Left Hand
AR-01384 Right Hand

692mm Height,
 325mm length,
 14.3mm Eye



Multi Weeder Rake Tine 19mm

AR-01385 Left Hand
AR-01386 Right Hand

692mm Height,
 325mm length,
 14.3mm Eye

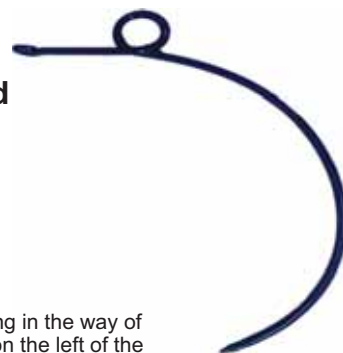

Standing behind the implement looking in the way of travel, if the mount arm (with eye) is on the left of the coil, it is a left hand tine. On the right hand side of the coil it is a right hand tine.

Multi Weeder Tracking Rake

AR-01449 Right Hand
AR-06919 Left Hand

Vertical Eye
 16mm Tine
 14.5mm Hole
 670mm Height

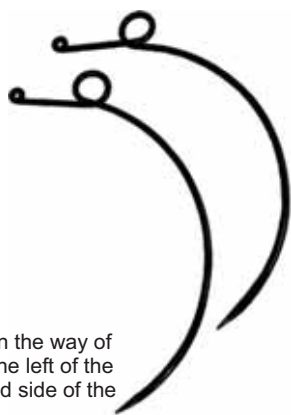

Standing behind the implement looking in the way of travel, if the mount arm (with eye) is on the left of the coil, it is a left hand tine. On the right hand side of the coil it is a right hand tine.

Tracking Rake Tine

AR-01448 Tine 16mm,

692mm Height
 365mm Length



Right Hand Tine, as the mount arm is on the right of the coil looking from behind. (Only available in one hand).

Cultivator Rake Tine 19mm with 25mm ID Ferrule

AR-01396 Height 686mm,
 Length 816mm

AR-01400 Height 686mm,
 Length 435mm

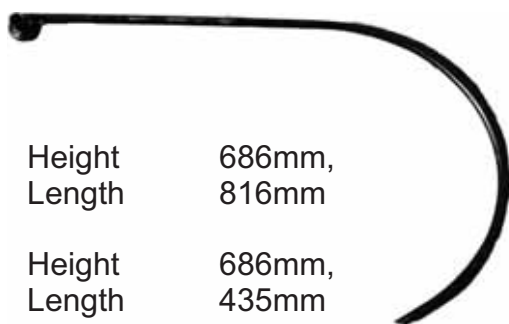

Crescent Knives

AR-05459 & AR-05460 LH & RH

11mm Hole & 11mm X 34mm Slot Hole
 @ 42mm centres.
 Length A = 290mm,
 Length B = 150mm
 50mm Wide x 10mm Thick



Struik Inter-Row Blade

AR-09217 210mm long x 40mm x 10mm thick

2 x 12mm holes at 60mm centres
 Approx 90mm long **TUNGSTEN WELD**



Baselier Bed Former Blade

AR-09213 335mm long x 40mm x 10mm thick

2 x 12mm holes at 80mm centres
 Approx 90mm long **TUNGSTEN WELD**



Ripper Legs, Points & U Bolts

Ripper Point suit Yeoman

TUNGSTEN HARD FACED - With Tile

ACAG-08742 Standard Hard Faced with tile



Wombat (Wb-3) style

Ripper Point suit Yeoman

H/DUTY TUNGSTEN HARD FACED

ACAG-08742H H/Duty Hard Faced
(With extra Rib at back of point)



Wombat (Wb-3) style

ASP Ripper Point

ACAG-003 Point - Suits ASP Ripper Legs



ASP Ripper Point

TUNGSTEN HARD FACED

ACAG-003HF - Suits ASP Ripper Legs



ASP Ripper Legs

- ACAG-024 24" Complete Assembly
- ACAG-031 30" Complete Assembly
- ACAG-001 24" Shank only
- ACAG-030 30" Shank only
- ACAG-SUB Clamp Assembly (Top & Bottom)

1" (25mm) shear pin

Breakout force approximately
4000ft.lbs for 24" Leg

Approximate power
requirements per shank:
7.5-11KW (10-15 HP)

Suits 100mm square RHS
frames. Best suited to frames
with hydraulic top link pins.

TUNGSTEN HARD FACING →
AS STANDARD ON
THE SHANK LEADING EDGE
(Standard Point & Guard supplied
with Complete Assembly).



ASP Ripper Leg Parts

- ACAG-015 Shin Guard
- ACAG-015HF **HARD FACED** Shin Guard
- ACAG-014 Shear Pin
- ACAG-EN761 Pin Clip



Ripper Point suit Gessner

TUNGSTEN HARD FACED

ACAG-09160H Gessner style Point
Oem Ref: 7004-025, 7004-026



Ripper Guard & Shear Pin Suit Gessner

- ACAG-09161H Hard Faced Shin Guard
Oem Ref: 7003-031
- ACAG-014 Shear Pin (refer above for size)
- ACAG-EN761 Pin Clip



Clamps & Wedges, Rotary Hoe Blades

Clamps & Wedges - 2" Toolbar

AR-04279 1" Tine to 2" Toolbar
AR-04285 Wedge to suit AR-04279

AR-04277 1 1/4" Tine to 2" Toolbar
AR-04283 Wedge to suit AR-04277

AR-04278 *Spreader Clamp*
AR-04283 Wedge to suit AR-04278



Clamps & Wedges - 2 1/2" Bar

AR-04273 1 1/4" Tine to 2 1/2" Toolbar
AR-04283 Wedge to suit AR-04273

AR-04274 *Spreader Clamp*
AR-04283 Wedge to suit AR-04274



Clamps & Wedges - 3 1/2" Bar

AR-01496 1 1/4" Tine to 3 1/2" Toolbar
AR-04346 Wedge to suit AR-01496

AR-01495 *Spreader Clamp*
AR-04346 Wedge to suit AR-01495



Clamps & Wedges - 4" Toolbar

AR-03896 1 1/4" Tine to 4" Toolbar
AR-04346 Wedge to suit AR-03896

AR-06964 *Spreader Clamp*
AR-04346 Wedge to suit AR-06964



U & V Bolts

ASP U Bolts are grade 8.8 high tensile. Complete with nuts & washers.



		Suit toolbar size	Leg & Thread Length
AR-07328	U Bolt	4 x 4 x 3/4"	6" with 2 1/4" thread
AR-315031K	U Bolt	7 x 7 x 3/4"	9" with 2 1/4" thread
AR-315032K	U Bolt	7 x 7 x 7/8"	9" with 1 1/4" thread
AR-315033K	U Bolt	6 x 4 x 3/4"	6" with 2 1/4" thread
AR-315034K	U Bolt	6 x 6 x 3/4"	8" with 3 1/4" thread
ASP-101-350	V Bolt	100x100x22mm	

DURA-TUNG RANGE FROM ASP!

THE DURABLE TUNGSTEN RANGE FROM ASP USES AN ULTRA TOUGH TUNGSTEN COATING FOR MAXIMUM WEAR RESISTANCE WHILST STILL MAINTAINING A SHARP CUTTING EDGE!

DESIGNED EXCLUSIVELY FOR THE AGRICULTURAL INDUSTRY.
AVAILABLE ON A SELECT RANGE OF ASP HOE BLADES.



Thin coating of fine grit TUNGSTEN hard facing along the cutting edge and bottom of the blade enables maximum wear resistance without reducing the cutting ability of the blade.



ASP Hoe Blades are sold in EQUAL QUANTITIES of left hand & right hand.

ASP Rotary Hoes blades are manufactured in Italy from Boron Steel. OEM numbers are for reference only.

ASP Rotary Hoe and Power Harrow blades are the hardest, longest lasting blades sold in Australia. They are super hardened to 50Rc where others often are softer. We can do this because our blades are made from European Boron steel which enables them to be made harder without the risk of them becoming brittle. As well, ASP blades undergo a special heat treatment process that produces different characteristics in the steel where really needed, extra hardness at the blade edge and extra elasticity at the bolt holes.

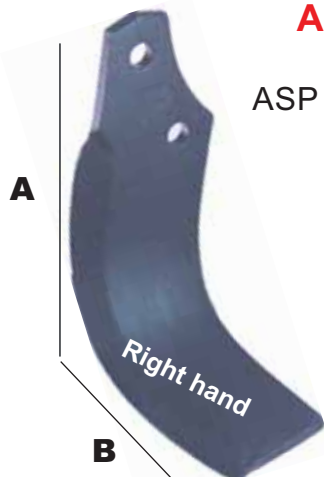

SPEED BLADE



POWER BLADE

Rotary Hoe Blades

APPLICATION OEM REF TYPE SIZE A SIZE B HOLE CENTRES SECTION BOLT

AGRATOR		RH-08782 - 10T & RH-08783 - 10T NEW HARD FACED 10mm THICK OPTION							
RH-08782 RH-08783	MRP SERIES	MR30856 MR30857	POWER 237004	193mm	140mm	16.5mm	75mm	105x8mm	RHA-08118D M16 X 48mm
				<i>*Tungsten Hard Faced Option available</i>					
RH-09146 RH-09147	MRP SERIES		SPEED 225046	210mm	140mm	16.5mm	75mm	105x8mm	RHA-08118D M16 X 48mm
BREVIGLIERI									
RH-08116 RH-08117	B83, 103, 123, 170, 250 DOBLE & MAXI	0064818 D/S	POWER 153016	185mm	135mm	14.5mm	57mm	80x8mm	RHA-08419 M14 X 40mm
				<i>*Tungsten Hard Faced Option available</i>					
RH-08924 RH-08925	H/DUTY 10MM		POWER 153064	180mm	135mm	14.5mm	57mm	80x10mm	RHA-08419L 9/16" X 2 1/4"
RH-08243 RH-08244	B83, 103, 123, 170, 250 DOBLE & MAXI	0064811 D/S	SPEED 153015	185mm	135mm	14.5mm	57mm	80x8mm	RHA-08419 M14 X 40mm
				<i>*Tungsten Hard Faced Option available</i>					
CELLI									
RH-08386 RH-08387	'A' SERIES	522514 522515	POWER 153011	185mm	135mm	12.5mm	50mm	70X6mm	N/A
RH-08392 RH-08393	ALPHA, C & CE	331526 331527	POWER 153027	185mm	135mm	14.5mm	50mm	70X7mm	RHA-08419 M14 X 40mm
RH-08390 RH-08391	ALPHA, C & CE	331528 331529	SPEED 153028	195mm	135mm	14.5mm	50mm	70X7mm	RHA-08419 M14 X 40mm
RH-08388 RH-08389	AG SERIES	531511 531512	SPEED 153025	164mm	110mm	12.5mm	40mm	60X6mm	N/A
RH-08116 RH-08117	E, HV, H, F, G, K, PIONEER, TIGER & ERGON	722533/34 422512/13 B6225/6	POWER 153016	185mm	135mm	14.5mm	57mm	80X8mm	RHA-08419 M14 X 40mm
				<i>*Tungsten Hard Faced Option available</i>					
RH-08924 RH-08925	H/DUTY 10MM	722547 722548	POWER 153064	180mm	135mm	14.5mm	57mm	80X10mm	RHA-08419L 9/16" X 2 1/4"
RH-08243 RH-08244	E, HV, H, F, G, K, PIONEER, TIGER & ERGON	722537/38 422514/15	SPEED 153015	185mm	135mm	14.5mm	57mm	80x8mm	RHA-08419 M14 X 40mm
				<i>*Tungsten Hard Faced Option available</i>					
RH-08986 RH-08987	LONG SHANK ALTERNATIVE TO RH-08116 / 7	B6229 / 30	POWER 153055	207mm	135mm	14.5mm	57mm	80x10mm	RHA-08419L 9/16" X 2 1/4"
				<i>*Tungsten Hard Faced Option available</i>					
RH-09177 RH-09178	SUPER TIGER	722560 722561	POWER 153060A	180mm	135mm	16.5mm	57mm	80x10mm	RHA-08118D M16 X 48mm
RH-09223 RH-09224	LONG SHANK SUPER TIGER		POWER 153055A	207mm	135mm	16.5mm	57mm	80X10mm	RHA-08118D M16 X 48mm

Rotary Hoe Blades

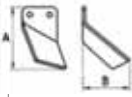
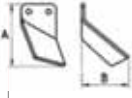
APPLICATION		OEM REF	TYPE	SIZE A	SIZE B	HOLE	CENTRES	SECTION	BOLT
FALC		RH-08782 - 10T & RH-08783 - 10T NEW HARD FACED 10mm THICK OPTION							
RH-08116 RH-08117	C,CS & E	762427 762428 884070/71	POWER 153016	185mm	135mm	14.5mm	57mm	80x8mm	RHA-08419 M14 X 40mm
RH-08924 RH-08925	H/DUTY ALTERNATIVE TO RH-08116 / 7		POWER 153064	180mm	135mm	14.5mm	57mm	80x10mm	RHA-08419L 9/16" X 2 1/4"
RH-08243 RH-08244	C,CS & E	884000 884001	SPEED 153015	185mm	135mm	14.5mm	57mm	80x8mm	RHA-08419 M14 X 40mm
RH-08782 RH-08783	F, G, GAMMA & KAPPA	762719 /20 25.09.59 / 60	POWER 237004	193mm	135mm	16.5mm	75mm	105x8mm	RHA-08118D M16 X 48mm
RH-09146 RH-09147	F, G, GAMMA & KAPPA	109343 109344	SPEED 225046	210mm	140mm	16.5mm	75mm	105x8mm	RHA-08118D M16 X 48mm
RH-08396 RH-08397	D SERIES	79970 79971	POWER 255012	215mm	140mm	14.5mm	56mm	80x8mm	RHA-08419 M14 X 40mm
FORIGO									
RH-09035 RH-09036	G35 STONE BURIER	G3596100 & 110		A 160mm	B 113mm	14.5mm	48mm	90X8mm	
RH-09037 RH-09038	G45 STONE BURIER	G4595000 & 5100		A 177mm	B 135mm	14.5mm	56mm	100X8mm	
HOWARD		RH-08782 - 10T & RH-08783 - 10T NEW HARD FACED 10mm THICK OPTION							
RH-08396 RH-08397	HR35 - R2 ROTOR	79970 79971	POWER 255012	215mm	140mm	14.5mm	56mm	80X8mm	RHA-08419 M14 X 40mm
RH-08105 RH-08106	R500,HR30,35,E , AR,ST	63604 63605 B4001 / 2	POWER 225026	173mm	142mm	13mm	57mm	90x8mm	RHA-08119 1/2" X 1 1/2 UNF
RH-08007 RH-08008	AH,CH,RC,R600 HR40-3,AH.S.M HR50-61s	9862 / 9863 B7001 / 2	POWER 225025	170mm	137mm	16.5mm	51mm	90x8mm	RHA-08118D M16 X 48mm
RH-08007-10 RH-08008-10	AH,CH,RC,R600 HR40-3,AH.S,M HR50-61s	9862 / 9863 B7001/2	POWER 225084DX	170mm	137mm	16.5mm	51mm	90x10mm	RHA-08118D M16 X 48mm
RH-08110 RH-08111	AH,CH,RC,R600 HR40-3,AH.S,M HR50-61s	9950 / 9951 B9001 / 2	SPEED 225072	210mm	145mm	16.5mm	51mm	90x8mm	RHA-08118D M16 X 48mm
RH-08112 RH-08113	LONG SHANK	9910 / 9911 B9003 / 4	POWER 225024	210mm	137mm	16.5mm	51mm	90x8mm	RHA-08118D M16 X 48mm
RH-08782 RH-08783	H/DUTY HR50, 60,61 F ROTOR	762719 762720 612719/20	POWER 237004	193mm	135mm	16.5mm	75mm	105x8mm	RHA-08118D M16 X 48mm

NOTE: PLEASE CHECK DIMENSIONS FOR CORRECT BLADES

Rotary Hoe Blades

APPLICATION OEM REF TYPE SIZE A SIZE B HOLE CENTRES SECTION BOLT

KRONE & KUHN

RH-08782 - 10T & RH-08783 - 10T NEW HARD FACED 10mm THICK OPTION

RH-08782 RH-08783	E, EL KUHN RF KRONE	52359600 52359700 52359000/1	POWER 237004	193mm	135mm	16.5mm	75mm	105x8mm	RHA-08118D M16 X 48mm
<i>*Tungsten Hard Faced Option available</i>									
RH-09146 RH-09147	E, EL KUHN RF KRONE		SPEED 225046	210mm	140mm	16.5mm	75mm	105x8mm	RHA-08118D M16 X 48mm
MASCHIO									
RH-08394 RH-08395	B, BI, C & SC SERIES (TERANOVA)	01110427 01110426	SPEED 255013	215mm	140mm	14.5mm	56mm	80x8mm	RHA-08419 M14 X 40mm
RH-08396 RH-08397	B, BI, C & SC SERIES (TERANOVA)	01110429 01110428	POWER 255012	205mm	140mm	14.5mm	56mm	80x8mm	RHA-08419 M14 X 40mm
RH-08398 RH-08399	G SERIES	20100413 20100412	SPEED 255025	257mm	148mm	16.5mm	68mm	90x10mm	RHA-08420 M16 X 58mm
RH-08400 RH-08401	G SERIES	20100415 20100414	POWER 255026	225mm	142mm	16.5mm	68mm	90x10mm	RHA-08420 M16 X 58mm
RH-08404 RH-08405	S SERIES	20100404 20100405	POWER 255028	225mm	145mm	16.5mm	56mm	90x8mm	RHA-08420
<i>*Tungsten Hard Faced Option available</i> <i>Check bolt length: RHA-08420, M16 x 58mm or RHA-08118 M16 x 48mm</i>									
RH-09153 RH-09154	PANTERA	09400419 09400418	POWER 255107	215mm	135mm	16.5mm	56mm	90x10mm	RHA-08420
<i>*Tungsten Hard Faced Option available</i> <i>Check bolt length: RHA-08420, M16 x 58mm or RHA-08118 M16 x 48mm</i>									
RH-09371 RH-09372	PANTERA		SPEED 255104	210mm	150mm	16.5mm	56mm	90x10mm	RHA-08420
<i>Check bolt length: RHA-08420, M16 x 58mm or RHA-08118 M16 x 48mm</i>									
SICMA									
RH-08116 RH-08117	SP & RG	S4814516 S4814517 4814002/03	POWER 153016	185mm	135mm	14.5mm	57mm	80x8mm	RHA-08419 M14 X 40mm
<i>*Tungsten Hard Faced Option available</i>									
RH-08243 RH-08244	SP & RG	S4814518 S4814519	SPEED 153015	195mm	135mm	14.5mm	57mm	80x8mm	RHA-08419 M14 X 40mm
<i>*Tungsten Hard Faced Option available</i>									
WECAN									
RH-08116 RH-08117	DGW & MGW LG80HP		POWER 153016	185mm	135mm	14.5mm	57mm	80x8mm	RHA-08419 M14 X 40mm
<i>*Tungsten Hard Faced Option available</i>									
VALENTINI									
RH-09153 RH-09154	ER HERCULES & MAXI SQUALO	4.2- 7.7MTR	POWER 255107	215mm	135mm	16.5mm	56mm	90 X 10	RHA-8420
<i>*Tungsten Hard Faced Option available</i> <i>Check bolt length: RHA-08420, M16 x 58mm or RHA-08118 M16 x 48mm</i>									

ASP HOE BLADES ARE SOLD IN EQUAL QUANTITIES OF LEFT & RIGHT HAND.
OEM REFERENCE NUMBERS ARE FOR IDENTIFICATION ONLY - NOT SOLD AS GENUINE.

Power Harrow Blades

Sold in equal quantities of left & right hand only.

PH-08784 & PH-08785

Suits **CELLI**
ER & Minigo, Go, Laser
Ranger & Energy
OEM Ref
622715
622716

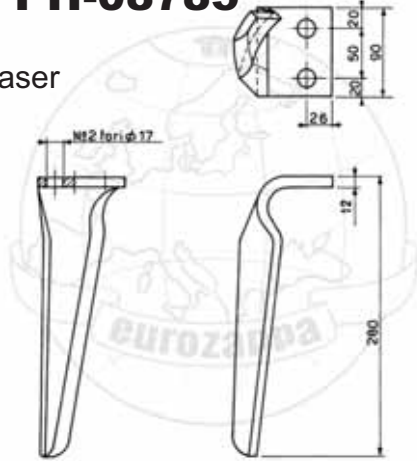

PH-08786 & PH-08787

Suits **CELLI**
KR & Maxi
OEM Ref
622603
622604

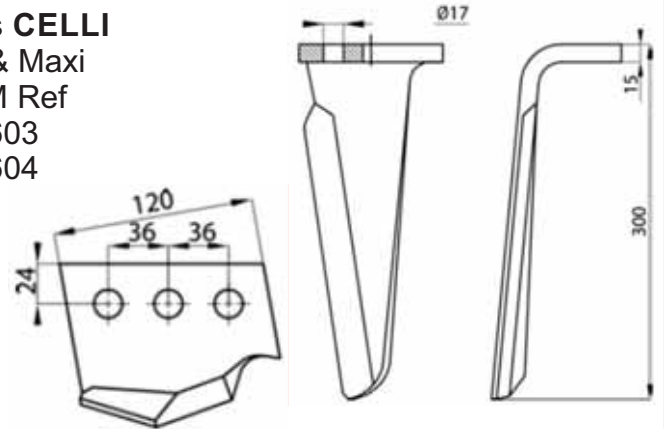

PH-08796 & PH-08797

Suits **KUHN & EMY**
HR & HRB
OEM Ref
525604
525605

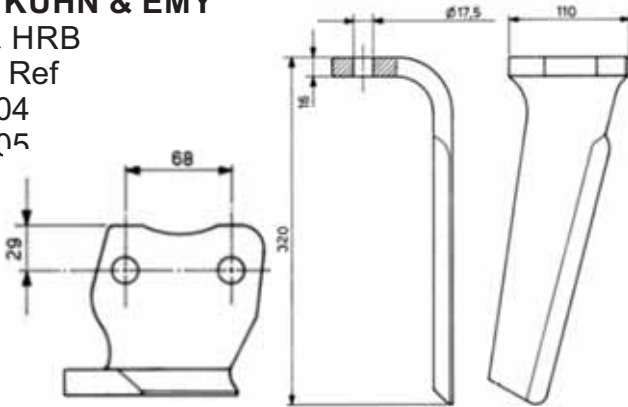

PH-08798 & PH-08799

Suits **KUHN & EMY**
HR & HRB
OEM Ref
52539400A
52539500A

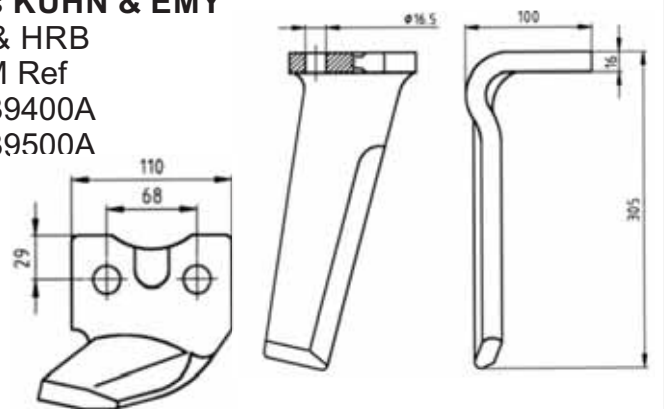

PH-08800 & PH-08801

Suits **CELLI** (ER, LASER, RANGER, GO ETC)
HOWARD (FALC & FOX), **MASCHIO** DC, DS, DL &
SICMA. OEM Ref
38100222/23, 512075/76,
E010146/20146

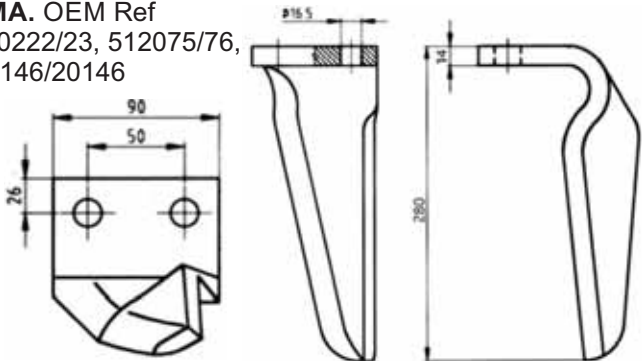

PH-08802 & PH-08803

Suits **MASCHIO**
DM & AQUILA
BREV. 36100215/6
OEM Ref
36100215/16

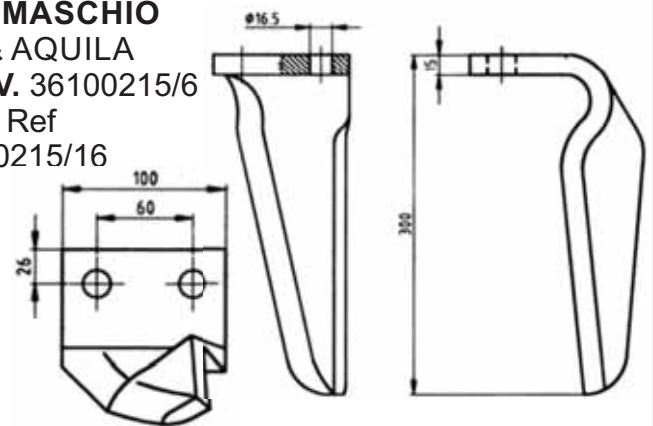

PH-09266

RINALDI R2 TINE

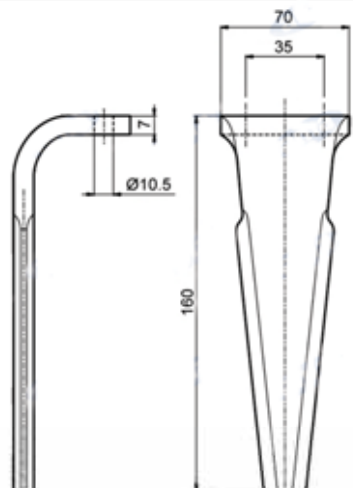

PHA-09360

M16 X 60mm Bolt & Nyloc nut
to suit some Celli, Kuhn &
Maschio tines.



Quick Fit Power Harrow Blades

PH-08930 & PH-08931

Suits AMAZONE
OEM Ref 962337
962338

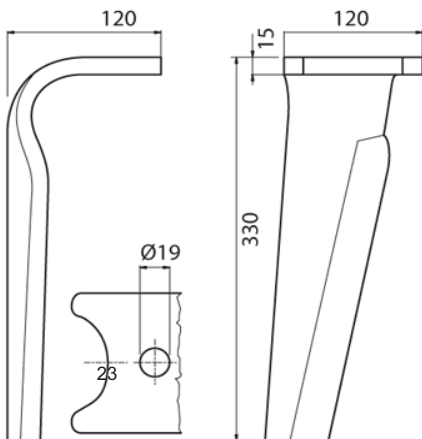

PH-09221 & PH-09222

Suits LELY - CLUB TINE
OEM Ref 116990111 / 112

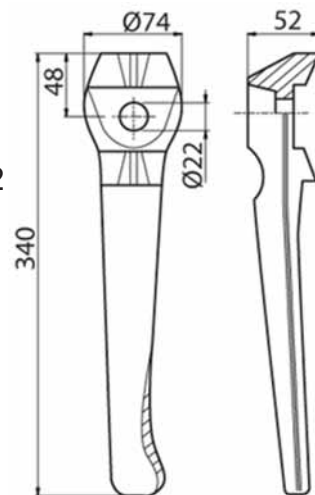

PH-09225 & PH-09226

Suits KUHN
OEM Ref 52596410
/ 52596510

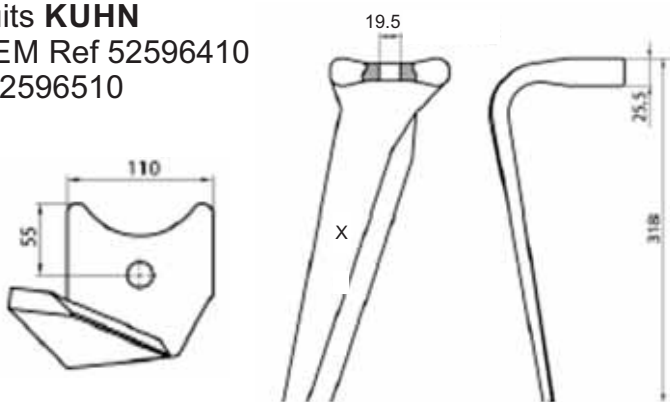

PH-09227 & PH-09228

Suits KUHN
OEM Ref K2500090
/100

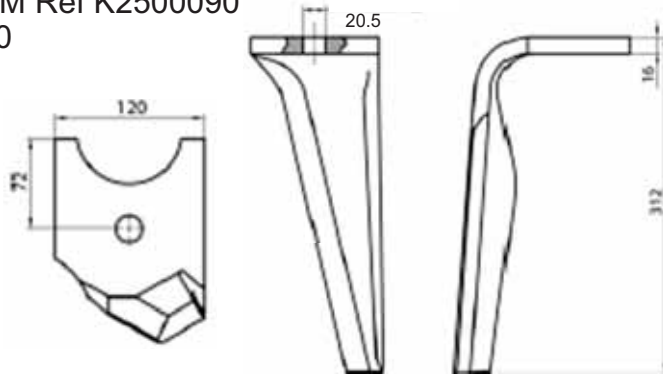

Right Hand

Left Hand



PHA-08804

Bolt Head Protector

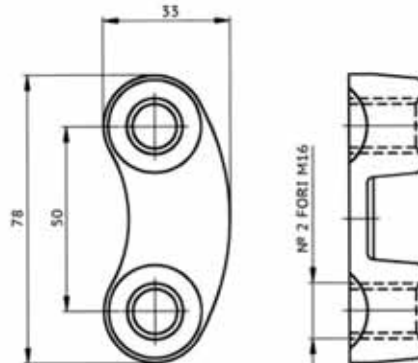

Notes:



Speed Tiller Discs

HORSCH

ASP-09401BB
ASP-09400BB

20" x 6mm Flat Back, 5 x 12.5mm Holes @ 106mm PCD suit Joker
24" x 6mm Flat Back, 6 x 12.5mm Holes @ 125mm PCD suit Joker HD

NEW
NEW

AMAZONE

ASP-08903BB
ASP-09229BB

20" x 4mm Flat Back, 4 x 12.5mm Holes @ 120mm PCD suit Catros
26" x 6mm Flat Back, 4 x 12.5mm Holes @ 170mm PCD suit Certos

JOHN DEERE

ASP-09289BB

20" x 6mm Flat Back, 4 x 12.5mm Holes @ 98mm PCD OEM 5NS90340002

K-LINE

ASP-1120
ASP-99
ASP-08858
ASP-09000
ASP-09380

22" x 5mm, 70mm Round Centre, 4 x 18mm @ 137mm PCD
24" x 6mm, 70mm Round Centre, 4 x 18mm @ 137mm PCD
26" x 6mm, 70mm Round Centre, 4 x 18mm @ 137mm PCD
28" x 6mm, 70mm Round Centre, 4 x 18mm @ 137mm PCD - **check fitment**
Jump Arm Rubber Mounts 50mm x 226mm OEM 29000JAX226

KUHN

ASP-09295

20" x 5mm Flat Back, 6 x 11mm Sq Holes @ 100mm PCD suit Optimer H2203180

LELY

ASP-09415
ASP-09029

20" x 5mm Flat Back, 62mm Rnd/key, 5 x 14.5mm Holes @112mm PCD **NEW**
22" x 5mm Flat back, 62mm Rnd/key, 5 x 14.5mm Holes @112mm PCD

MASCHIO

ASP-09289BB
ASP-09397BB

(also fits Farnet OEM 3007653 & Norwood Quicktill with SKF BAA Hubs)
20" x 5mm Flat Back, 4 x 12.5mm Holes @ 98mm PCD OEM M65400214
22" x 6mm Flat Back, 4 x 12.5mm Holes @ 98mm PCD

NEW

POTTINGER

ASP-09138

22" x 5mm Flat Back, 4 x 12.5mm Holes @ 110mm PCD, 56mm Dish



 **LA PIÑA**

BoronBlue™

Agricultural Discs

ASP Discs are among the finest, longest wearing BORON discs manufactured in the world.

All ASP Discs & Coulters come with a warranty, guaranteeing the user maximum working life.

Don't settle for high carbon steel discs...

INSIST ON ASP BORON STEEL!

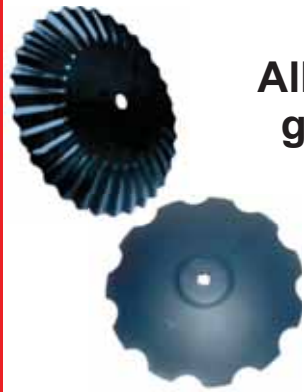

BoronBlue™

Reference Chart - Machine Make

AITCH	AITCHISON	D	DUNCAN	HU	HUTCHMASTER	MIL	MILLER
ALFM	ALFARM	DB	DAVID BROWN	IH	INT. HARVESTER	MSW	MOURILYN
BNL	BONEL	E	ENNOR ENG	JA	JARRETT	NG	NAPIER
BH	BUSH HOG	ES	EASY-FIX	JB	JOHN BERENDS	SH	SHEARER
BR	BIG RIG	EZ	EZEE-ON	JD	JOHN DEERE	SOV	SOVEREIGN
BT	BETTINSON	GZY	GRIZZLY	JK	JANKE	STG	STEIGER
CH	CHAMBERLAIN	GR	GIBBONS	KEL	KELLOW	TW	TAYLORWAY
CL	CLOUGH	GN	GESSNER	KRS	KRAUSE	TNR	TOWNER
CA	CASE	HE	HODGE	MA	MANNUM AG	W	WILLETT
CS	CONNOR SHEA	HB	H-BAGSHAW	MF	MASSEY FERG	WK	WALKER
CW	COUNTRY WIDE	HT	HOLDEN HT	MH	MURRAY	Y	YEOMAN

SCALLOP & FLUTED DISCS

18"										
ASP-6C	5 MM	56 MM	DUAL SQUARE	30 MM & 33 MM			NG, JA, BNL	184-092SD	1815-S-8	6
20"										
ASP-12C	4 MM	58 MM	DUAL SQUARE	27 MM & 30 MM			SH,JA,BNL,NG,GR	204-102SD	2015-S-2	6
ASP-08903BB	4 MM	58 MM	NIL		4 X 12 MM	120 MM	AMAZONE CATROS			6
ASP-13C	4 MM FLAT BACK	45 MM	DUAL SQUARE	27 MM & 30 MM			IH, MF, MH	204-7FSD		6
ASP-09289BB	6 MM FLAT BACK	54 MM	NIL		4 X 12.5MM	98 MM	MASCHIO, KWICKTILL M65400214	206-2SFB		9
ASP-09295	5 MM FLAT BACK	52 MM	NIL		6 X 11 MM	100 MM	KUHN OPTIMER H2203180			8
ASP-09415	5 MM FLAT BACK	52 MM	ROUND - KEY	62 MM	5 X 14.5 MM	112 MM	LELY TULIP MULTI DISC (TRI RUBBERS)	20025		8
ASP-09401	6 MM FLAT BACK	52 MM	NIL		5 X 13MM	106 MM	HORSCH JOKER	206-1SFB		9
22"										
ASP-34C	4 MM	60 MM	DUAL SQUARE	27 MM & 30 MM			JA, DB			8
ASP-1120	5 MM	63 MM	ROUND	70 MM	4 X 18 MM	137 MM	k-LINE SPEED TILLER & GZY GRUMPY	225-3SB	22044	10
ASP-41C	5 MM	70 MM	DUAL SQUARE	30 MM & 33 MM			NG340, HDGE, BNL, JB			10
ASP-43	5 MM	70 MM	ROUND	70 MM	6 X 18 MM	113 MM	CS, BABY GIANT	225-171SB	2218-SB-1	10
ASP-42C	5 MM FLAT BACK	70 MM	DUAL SQUARE	27 MM & 30 MM			IH 3-4, MF, MH	225-95FD	2218-SF-1/9	10
ASP-09029	5 MM FLAT BACK	60 MM	ROUND - KEY	62 MM	5 X 14.5 MM	112 MM	LELY TULIP OEM 760020033	22028		10
ASP-09138	5 MM FLAT BACK	56 MM	NIL		4 X 12.5 MM	110 MM	POTTINGER			10
ASP-09397BB	6 MM FLAT BACK	68 MM	NIL		4 X 12.5 MM	98 MM	MASCHIO, KWICKTILL & J/D	226-2SFB		11
24"										
ASP-92C	5 MM	76 MM	DUAL SQUARE	30 MM & 33 MM			SH 500, NG 690, HDGE 245-288SD	245-226S	2418-S-15	11
ASP-09294BB	5 MM FLAT BACK	70 MM	DUAL SQUARE	27 MM & 30 MM			IH 3-4, MF, MH			11
ASP-100C	6 MM	76 MM	DUAL SQUARE	30 MM & 33 MM			SH, HDGE, BNL, NG, JD, BH	246-43SD	2425-S-37/40	13
ASP-100C-F	6 MM FLUTED	76 MM	DUAL SQUARE	30 MM & 33 MM			SH, HDGE, BNL, NG, JD, BH			13
ASP-101C	6 MM	76 MM	DUAL SQUARE	39 MM & 41 MM			HDGE, BNL, NG, IH, JA, SH, GR670	246-38SD	2425-S-8/38	13
ASP-101C-F	6 MM FLUTED	76 MM	DUAL SQUARE	39 MM & 41 MM			HDGE, BNL, NG, IH, JA, SH, GR670			13
ASP-103	6 MM	84 MM	ROUND	70 MM	6 X 18 MM	113 MM	CS BABY GIANT, CS710, 760, 780	246-1SB	2425-SB-1	13
ASP-99	6 MM	75 MM	ROUND	70 MM	4 X 18 MM	137 MM	K-LINE & GRIZZLY GRUMPY	246-3SB	2425-SB-3	13
ASP-09400	6 MM FLAT BACK	60 MM	NIL		6 X 12.5 MM	125 MM	HORSCH JOKERHD OEM 00311103			13

Agricultural Discs

PART NUMBER	THICK	CONCAVE	CENTER HOLE	CENTER HOLE SIZE MM	RADIAL HOLES	PCD	DESCRIPTION	AGPOINT PART NO	GWT/ McCOY PART NO	KG	
SCALLOP & FLUTED DISCS											
26"											
ASP-133	6 MM	57 MM	ROUND	25.4 MM	4 X 18 MM	228 MM	MSW			16	
ASP-138	6 MM	67 MM	ROUND	135 MM	4 X SQ13.5 MM	228 MM	BNL TRASH INCORP	266-138S		16	
ASP-139	6 MM	89 MM	ROUND	100 MM	6 X 22 MM	185 MM	GRIZZLY	266-26SB	2625-SB-26	16	
ASP-1322	6 MM FLAT BACK	81 MM	SQUARE	39 MM			IH, 770, 590, 501	266-15F	26161	16	
ASP-140	6 MM	91 MM	ROUND	78 MM	6 X 22 MM	190 MM	CS LITTLE GIANT, CS780, E, BNL	266-15B	2625-SB-1	16	
ASP-141C	6 MM	81 MM	DUAL SQUARE	39 MM & 41 MM			KUHN DISC XM2, HDGE, BNL, NG670, 710-740, JA	266-49SD	2625-S-14/35	16	
ASP-143C	6 MM	91 MM	DUAL SQUARE	54 MM & 60 MM			SH 700, IH3-5	266-16SD	26143C	16	
ASP-143C-F	6 MM	91 MM	DUAL SQUARE	54 MM & 60 MM			SH 700, IH3-5		26143CW	16	
ASP-160C	6 MM	91 MM	DUAL SQUARE	30 MM & 33 MM			JD, HDGE, BNL, BH			16	
ASP-09229BB	6 MM FLAT BACK	60 MM	NIL		4 X 12.5 MM	170 MM	AMAZONE CERTOS			16	
ASP-160SH	6 MM	68 MM	DUAL SQUARE	30 MM & 33 MM			TW, HE, JA, FORD 690	266-9SD		16	
ASP-08858	6 MM	83 MM	ROUND	70 MM	4 X 18 MM	137 MM	K-LINE, ROCCA IND. & GRUMPY	266-3SB		16	
ASP-08858-F	6 MM FLUTED	83 MM	ROUND	70 MM	4 X 18 MM	137 MM	K-LINE SPEED TILLER & GRUMPY			16	
ASP-151	8 MM	89 MM	ROUND	100 MM	6 X 22 MM	185 MM	GRIZZLY	268-25B	2631-SB-2	20	
ASP-152	8 MM	95 MM	ROUND	52 MM			STG, EZ, CW	268-7S	2631-S-3	20	
ASP-153	8 MM	100 MM	ROUND	78 MM	6 X 22 MM	190 MM	CS 780, CS LITTLE GIANT, BNL, E	268-15B	2631-SB-1	20	
ASP-154C	8 MM	81 MM	DUAL SQUARE	39 MM & 41 MM			HDGE, BNL, NG, ALLIS, JA	268-49SD		20	
ASP-155	8 MM	91 MM	ROUND	58 MM			KELLOW	268-155S	2631-S57	20	
ASP-1263	8 MM FLAT BACK	81 MM	SQUARE	39 MM			IH, 770, 590, 501	26162		20	
27"											
ASP-09369	6 MM	62 MM	NIL		6 X 16MM	150 MM	HORSCH TIGER	276-1SFB		17	
28"											
ASP-09000	6 MM	81 MM	ROUND	70 MM	4 X 18 MM	137 MM	K-LINE SPEED TILLER			19	
ASP-1178	6 MM	102 MM	DUAL SQUARE	54 MM & 60 MM			IH 3-5, SH700	286-1021S	28185C	19	
ASP-166C	6 MM	69 MM	DUAL SQUARE	39 MM & 41 MM			CN, SH, NG, BNL, HE, JA	286-29SD		19	
ASP-167C	6 MM	102 MM	DUAL SQUARE	39 MM & 41 MM			HDGE, BNL, NG670, JA, SH	286-606SD	2825-S-95	19	
ASP-167C-F	6 MM FLUTED	102 MM	DUAL SQUARE	39 MM & 41 MM			HDGE, BNL, NG670, JA, SH			19	
ASP-168-S	6 MM	102 MM	ROUND	100 MM	6 X 22 MM	185 MM	GRIZZLY	286-8SB	2825-SB-8	19	
ASP-170	6 MM	102 MM	ROUND	78 MM	6 X 22 MM	190 MM	E, BNL, CS, LITTLE GIANT	286-1013S		19	
ASP-168	8 MM	102 MM	ROUND	100 MM	6 X 22 MM	185 MM	GRIZZLY	288-15B	28169S	24	
ASP-168-F	8 MM FLUTED	102 MM	ROUND	100 MM	6 X 22 MM	185 MM	GRIZZLY	288-1WB	28169W	24	
ASP-171	8 MM	102 MM	ROUND	78 MM	6 X 22 MM	190 MM	E, BNL, CS, LITTLE GIANT	288-1086SB	2831-SB2	24	
ASP-175C	8 MM	102 MM	DUAL SQUARE	39 MM & 41 MM			CS, HDGE, BNL, MSW	288-1073S		24	
ASP-175C-F	8 MM FLUTED	102 MM	DUAL SQUARE	39 MM & 41 MM			CS, HDGE, BNL, MSW			24	
ASP-178	8 MM	102 MM	ROUND	52 MM			CW, EZEE & STG	288-17S		24	
ASP-08981	8 MM	102 MM	ROUND	44 MM			TATU	28183		24	
ASP-08968	8 MM	102 MM	ROUND	46 MM			DELMAD & BALDAN	28177		24	
ASP-179	8 MM FLAT BACK	92 MM	SQUARE	40 MM			IH 770	288-15F	2831-SF-1	24	
ASP-174	10 MM	102 MM	ROUND	100 MM	6 X 22 MM	185 MM	GRIZZLY	2810-2SB		30	
30"											
ASP-08812	8 MM	94 MM	ROUND	52 MM			CW			28	
32"											
ASP-190	8 MM FLAT BACK	110 MM	SQUARE	46 MM			IH 780	328-15F	3231-SF-1	33	
ASP-193-C	10 MM	112 MM	SQUARE	59 MM SQ & 62MM ROUND			ALFARM 080, TNR620	3210-10SD	3237-S-10	40	
ASP-199S	10 MM	112 MM	ROUND	100 MM	6 X 22 MM	185 MM	GRIZZLY (10 TEETH)	3210-2SB	32199S	40	
36"											
ASP-09262	12 MM	123 MM	ROUND	100 MM	6 X 22 MM	185 MM	GRIZZLY TINY (10 TEETH)	3612-2SB		63	
PLAIN DISCS											
28"											
ASP-08561	8 MM FLAT BACK	95 MM	SQUARE	40 MM			IH 770			24	
30"											
ASP-09112	6 MM	100 MM	ROUND	25 MM	NOT HEAT-TREATED, SUITABLE ONLY FOR FIRE PITS						

Coulters

NUMBER	THICK	STYLE	BEVEL	CENTER HOLE	CENTER HOLE SIZE MM	RADIAL HOLES	PCD	DESCRIPTION	AGPOINT PART NO	GWT PART NO	KG
10.8"											
ASP-6195	3 MM	PLAIN	DOUBLE	ROUND	72 MM	5 X 9 MM	95 MM	CS 470 DRILLS	C1103	6195	1.5
12.5"											
ASP-6197A	3 MM	PLAIN	DOUBLE	ROUND	52 MM	4 & 6 MULTI	10.5 @ 95 MM	DUNCAN (10.5MM HOLES)	C1208	6281	2
13"											
ASP-08988	3 MM	FLUTED	SINGLE	ROUND	20 MM	6 X 6.7 MM	75 MM	SKF AGRI HUB			2
13.5"											
ASP-6198	3 MM	PLAIN	DOUBLE	ROUND	72 MM	5 X 9 MM	95 MM	CS 470 DRILLS	C1320	6336	2
15"											
ASP-1117	4 MM	15 SCALL	SINGLE	ROUND	45 MM	6 X 8.7 MM	76 MM	AGROWPLOW			4
ASP-1118	4 MM	11 SCALL	SINGLE	ROUND	45 MM	6 X 8.7 MM	76 MM	AGROWPLOW			4
ASP-09393	4 MM	PLAIN	SINGLE	ROUND	52 MM	6 X 10.4MM	95 MM	DUNCAN ENVIRO OEM 22002			4
ASP-09394	5 MM	SCALLOP	SINGLE	ROUND	52 MM	6 X 10.4MM	95 MM	DUNCAN ENVIRO OEM 60841			4
16"											
ASP-6408	3 MM	PLAIN	SINGLE	ROUND	25 MM	6 X 7 MM	73 MM	MASON EXCEL PLANTER	C1609		3
ASP-6407/5	5 MM	PLAIN	DOUBLE	ROUND	64 MM	5 X 13 MM	108 MM	HOLDEN HT HUB, Y, GN, CS	C1635	6407	5
18"											
ASP-1011	4 MM	FLUTED	FLUTED	ROUND	63.5 MM	5 X 13 MM	108 MM	HOLDEN HT HUB, YEOMAN	C1860W	6473	5
ASP-6200	5 MM	PLAIN	SINGLE	ROUND	77 MM	4 X 10.5 MM	112 MM	JOHN DEERE	C1870	6480	6
ASP-09132	6 MM	PLAIN	SINGLE	ROUND	64 MM	5 X 13 MM	108 MM	HT, YEOMAN, GN, CS	C1872	6472	6
ASP-08878	6 MM	PLAIN	DOUBLE	ROUND	78 MM	5 X 13 MM	108 MM	SPRING RIDGE ENG	C1874		6
ASP-09406	4 MM	PLAIN	DOUBLE	ROUND	80 MM	5 X 14 MM	108 MM	WILLIAMS, RFM RETRO FIT	C1840RF		5
ASP-09407	4 MM	SCALLOP	SINGLE	ROUND	80 MM	5 X 14MM	108 MM	WILLIAMS, RFM RETRO FIT	C1840RFS		5
ASP-09260	5 MM	PLAIN	DOUBLE	ROUND	80 MM	5 X 14 MM	108 MM	GRAYTILL, RFM RETRO FIT ETC			6
ASP-09261	5 MM	SCALLOP	SINGLE	ROUND	80 MM	5 X 14MM	108 MM	GRAYTILL, RFM RETRO FIT ETC			6
20"											
ASP-1171	6 MM	PLAIN	SINGLE	ROUND	64 MM	5 X 13 MM	108 MM	HT, VARIOUS STALK CUTTERS	C2072	6523	10
ASP-08865	6 MM	PLAIN	DOUBLE	ROUND	64 MM	5 X 13 MM	108 MM	Y, HT, GN, CS, GIANT	C2070	6522	10
20.5"											
ASP-09350BB	6 MM	PLAIN	SINGLE	ROUND	93 MM	4 X 17MM	127 MM CSK	BOSS & BOURGAULT 921-010	C2072	6523	9
22"											
ASP-1061A	5 MM	SCALLOP	SINGLE	ROUND	74 MM	6 X 13 MM	105 MM CSK	NVI, BAKER			9
ASP-09320BB	6 MM	PLAIN	SINGLE	ROUND	64 MM	5 X 13 MM	108 MM	HT, DOUBLE DISC OPENER ETC	C2272		12
26"											
ASP-6667	6 MM	PLAIN	DOUBLE	ROUND	47 MM	4 X 18 MM	165 MM	HODGE	C2608		14
ASP-6668	6 MM	PLAIN	DOUBLE	ROUND	51 MM	4 X SQ 14 MM	165 MM CSK	HODGE	C2609		14
ASP-6670	6 MM	PLAIN	DOUBLE	ROUND	102 MM	8 X 13 MM	292 MM	BONEL	C2610		14
ASP-6671	6 MM	PLAIN	DOUBLE	ROUND	64 MM	5 X 13 MM	108 MM	HOLDEN HT HUB, Y, GN, CS	C2612		14
30"											
ASP-6202	6 MM	PLAIN	DOUBLE	ROUND	102 MM	8 X 12 MM	292 MM	BONEL	C3014		21
ASP-6766	6 MM	PLAIN	DOUBLE	ROUND	51.5 MM	4 X 18 MM	165 MM	HODGE & GESSNER	C3015		21
ASP-6202/8	8 MM	PLAIN	DOUBLE	ROUND	102 MM	8 X 12 MM	292 MM	BONEL	C3014		26
ASP-6766/8	8 MM	PLAIN	DOUBLE	ROUND	51.5 MM	4 X 18 MM	166 MM	HODGE & GESSNER	C3015		26
ASP-6202/10	10 MM	PLAIN	DOUBLE	ROUND	102 MM	8 X 12 MM	292 MM	BONEL			35
ASP-6766/10	10 MM	PLAIN	DOUBLE	ROUND	51.5 MM	4 X 18 MM	166 MM	HODGE & GESSNER			35



**ASP CAN MANUFACTURE MOST STYLES & SIZES OF DISCS & COULTERS.
PLEASE CONTACT US TO DISCUSS YOUR REQUIREMENTS.**



OEM & Competitors part numbers are for reference only. ASP encourages you to measure your Discs & Coulters prior to ordering.

Slasher Blades

AGRIFARM



BoronBlue™



Part Number	Description	LENGTH	HOLE	WIDTH	THICK	STEP
BS-01724	Suction Lift Blade Left hand cut BSA-00179 Bush BSA-09081 Bolt & Nut	355MM	32MM	75MM	12MM	40MM



BEN WYE

Part Number	Description	LENGTH	HOLE	WIDTH	THICK	STEP
BS-01724	Suction Lift Blade, Left hand cut BSA-00179 Bush BSA-100675 Bolt BSA-100852 Nut	355MM	32MM	75MM	12MM	40MM



BS-01724R	Suction Lift Blade, Right hand cut BSA-00179 Bush BSA-100675 Bolt BSA-100852 Nut	355MM	32MM	75MM	12MM	40MM
-----------	---	-------	------	------	------	------



BERENDS (John Berends Implements)

Part Number	Description	LENGTH	HOLE	WIDTH	THICK	STEP
BS-02003	Standard step down blade to suit 6 & 7' EHD Left hand cut, OEM Ref: 2003 BSA-02003B BUSH BSA-PG1112 BOLT BSA-PG1113 NUT	465MM	38MM	100MM	12MM	25MM
BS-02000	Standard step down blade to suit 6' HD Double edge LH & RH OEM Ref: 2000, 2005 BSA-00178 BUSH BSA-PG1112 BOLT BSA-PG1113 NUT	495MM	32MM	75MM	10MM	25MM
BS-01602	Suction Lift blade to suit 6' Side Discharge Left hand cut, OEM Ref: 1987 BSA-00180 BUSH BSA-PG1112 BOLT BSA-PG1113 NUT	460MM	32MM	75MM	16MM	40MM
BS-01585	Flat reversible blade to suit 6' HD Left hand cut, OEM Ref: 1984 BSA-00178 BUSH BSA-PG1112 BOLT BSA-PG1113 NUT	495MM	32MM	75MM	10MM	N/A
BS-01981	Flat reversible blade to suit 4'6" & 5' HD Left hand cut, OEM Ref: 1981 BSA-01981B BUSH BSA-PG1112 BOLT BSA-PG1113 NUT	368MM	26MM	75MM	10MM	N/A

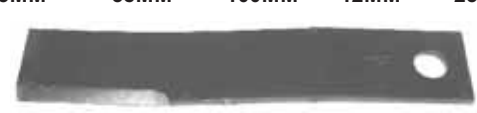

Please note: Slasher blades are measured from the centre of the bolt hole!

Part Number	Description	LENGTH	HOLE	WIDTH	THICK	STEP
BS-09416	Stepped, Double edge blade to suit 5, 8 & 10" HD & Multi G/Box slashers. OEM Ref: 2004 NEW BSA-00178 BUSH BSA-PG1112 BOLT BSA-PG1113 NUT	368MM	32MM	75MM	10MM	25MM
BS-04457	Standard step down blade to suit EP slashers Left hand cut, OEM Ref: 1980, B6005 BSA-04457B BUSH BSA-PG1112 BOLT BSA-PG1113 NUT	262MM	25MM	65MM	8MM	25MM
BS-01582	Standard step down blade to suit Pasture Toppers Left hand cut, OEM Ref: 1801 BSA-00175 BUSH BRA-100196 BOLT BSA-100285 NUT	275MM	25MM	65MM	7MM	38MM

CHRIS GROW & GASON

Part Number	Description	LENGTH	HOLE	WIDTH	THICK	STEP
BS-09043	Double Edge blade to suit 5' & Multi Gearbox OEM Ref: 225803 BSA-00178 BUSH BSA-100675 BOLT BSA-100852 NUT	250MM	32MM	100MM	10MM	40MM
BS-09044	Double Edge blade to suit 5' & Multi Gearbox OEM Ref: 226572 BSA-00179 BUSH BSA-100675 BOLT BSA-100852 NUT	350MM	32MM	100MM	13MM	40MM
BS-09045	Double Edge blade to suit 6' & Multi Gearbox OEM Ref: 224936 BSA-00179 BUSH BSA-100675 BOLT (BSA-S3393, 4" bolt for Mulch setup) BSA-100852 NUT	450MM	32MM	100MM	13MM	40MM
BS-09047	Suction Lift blades (10mm thick) to suit 5' & Multi Gearbox OEM Ref: 226571 RH & 226570 LH BSA-00178 BUSH	250MM	32MM	100MM	10MM	70MM
BS-09046	Left Hand Cut BSA-100675 BOLT BSA-100852 NUT	BS-09047				BS-09046
BS-08923	Suction Lift blades (10mm thick) to suit 5' & Multi Gearbox OEM Ref: MC1525/1625, 226427LH & 226428 RH BSA-00178 BUSH	357MM	32MM	100MM	10MM	70MM
BS-08922	Left Hand Cut BSA-100675 BOLT BSA-100852 NUT	BS-08923				BS-08922
BS-09048	Suction Lift blade to suit 6' & Multi Gearbox OEM Ref: 225159 (RH) & 225158 (LH) BSA-00178 BUSH	450MM	32MM	100MM	10MM	75MM
BS-09049	Left Hand Cut BSA-100675 BOLT BSA-100852 NUT	BS-09048				BS-09049
BS-09050	Suction Lift blades (13mm thick) to suit 5' & Multi Gearbox OEM Ref: 226569 RH & 226568 LH BSA-00179 BUSH	250MM	32MM	100MM	13MM	70MM
BS-09051	Left Hand Cut BSA-100675 BOLT BSA-100852 NUT	BS-09050				BS-09051

Part Number	Description	LENGTH	HOLE	WIDTH	THICK	STEP
BS-08226 Right Hand Cut	Suction Lift blades to suit 5' & Multi Gearbox OEM Ref: Mc1520 226511(RH) & Mc1620 226512(LH)	357MM	32MM	100MM	13MM	60MM
BS-08227 Left Hand Cut	BSA-00179 BUSH BSA-100675 BOLT BSA-100852 NUT	BS-08226				BS-08227
BS-08228 Right Hand Cut	Suction Lift blade to suit 6' & Multi Gearbox OEM Ref: Mc1500, 223542 (RH) & Mc1600, 223543 (LH)	450MM	32MM	100MM	13MM	65MM
BS-08229 Left Hand Cut	BSA-00179 BUSH BSA-100675 BOLT BSA-100852 NUT	BS-08228				BS-08229

DAKEN

Part Number	Description	LENGTH	HOLE	WIDTH	THICK	STEP
BS-00467	Twisted double edge blade to suit 5' Left hand cut, OEM Ref: BSA-06394B BUSH BSA-07453K BOLT & NUT KIT (1 bolt & 1 nut)	330MM	38MM	100MM	10MM	N/A
BS-01724	Suction Lift blade to suit 6' Left hand cut - "Will only suit certain Models" BSA-00179 BUSH BSA-100675 BOLT BSA-100852 NUT	355MM	32MM	75MM	12MM	40MM
BS-01583	Suction Lift blade to suit 759 Series slashers Left hand cut, OEM Ref: 55475DC Bare-co B6000 - Check blade length. BSA-00178 BUSH BSA-100675 BOLT BSA-100852 NUT	485MM	32MM	75MM	10MM	45MM

DIGGA

Part Number	Description	LENGTH	HOLE	WIDTH	THICK	STEP
BS-09271	Step, Double edge blade Suit 1500 & 1800 Skid Steer Short Style - Check Blade length BSA-09272 BOLT & NUT	350MM	38MM	100MM	13MM	40MM

GESSNER

Part Number	Description	LENGTH	HOLE	WIDTH	THICK	STEP
BS-01586	Standard Step down blade to suit 15'6" & 21'6" Double edge LH & RH BSA-00175 BUSH BSA-08089 BOLT KIT (1x bolt, bush & nut)	250MM	25MM	65MM	7MM	22MM

FIELDQUIP - Including BUSH HOG & RHINO

Part Number	Description	LENGTH	HOLE	WIDTH	THICK	STEP
BS-01583	Suction Lift blade suit LE60, 70 & LS70 slashers L/Hand cut, OEM Ref: 21003, FQ6000, B6000 BSA-00178 BUSH BSA-100675 BOLT BSA-100852 NUT	490MM	32MM	75MM	10MM	45MM
BS-09075	Stepped & Fluted blade suit 5ft deck Bush Hog Ls1500 & LH1500 OEM Ref 36BH, 7555BH Left Hand cut BSA-09087 Bolt Kit OEM Ref 7919BH	563MM	38MM	75MM	12MM	50MM
BS-08141	Stepped & Fluted blade suit 6ft deck Bush hog Ls1800 & Rhino 6200 OEM Ref 7556BH, 19160 Left Hand cut BSA-09087 Bolt Kit OEM Ref 7919BH BSA-09405 Square Shank bolt to suit Rhino using our BS-08141 blade	645MM	38MM	100MM	13MM	58MM
BS-09076	Stepped & Fluted blade suit 7ft deck Bush Hog Ls2100 & LH2100 OEM Ref 7557BH Left Hand cut BSA-09087 Bolt Kit OEM Ref 7919BH	714MM	38MM	100MM	13MM	65MM
BS-08139	Stepped & Fluted blade suit RH272 & RH472 OEM Ref 00780882 Left Hand cut	571MM	38MM	100MM	13MM	58MM
BS-01724	Suction lift blade to suit XHD90 etc OEM Ref: 6002, Bare-co B6002 BSA-00179 Bush	355MM	32MM	75MM	12MM	40MM
BS-08923	Suction Lift blades (10mm thick) to suit GEARMOWER GM30-900 etc Right Hand Cut	357MM	32MM	100MM	10MM	70MM
BS-08922	BSA-07453K BOLT & NUT BSA-09385 BUSH Left Hand Cut	BS-08923				BS-08922
BSA-09087	Bolt & nyloc nut. 1 1/8" thread, 75mm long from under head, 37.5mm x 14mm wide blade shank. Replaces key style bolt as has 2 flats on head for fitment / removal.					
BSA-09405	Square shank bolt & nyloc nut. 65mm round head x 11mm thick. 37.8mm shank to suit 38mm hole in blade with 26.9mm square section x 28mm long. 1" thread size x 2" long. Suits 6200 Rhino using BS-08141 blade.					

HIMAC

Part Number	Description	LENGTH	HOLE	WIDTH	THICK	STEP
BS-08922 Left Hand Cut	Suction Lift blade to suit 4 Foot slasher (New style) Please check blade length. Check bolt BSA-09367	357MM	32MM	100MM	10MM	70MM

Part Number	Description	LENGTH	HOLE	WIDTH	THICK	STEP
BS-09366	Suction Lift blade suit HiMac Slashers OEM Ref BLADESL, H34849A Left Hand cut Use BSA-09367 Bolt, Nut & Washer	495MM	32MM	75MM	10MM	55MM
BS-09264	Stepped Double Edge blade suit BrushCutters OEM Ref BLADESLBCO, SB60 Use BSA-09368 Bolt, Nut & Washer	415MM	38MM	100MM	12MM	65MM

HOWARD

Part Number	Description	LENGTH	HOLE	WIDTH	THICK	STEP
BSA-00484	Nib style Beam / Head flat to suit 5 foot slasher OEM Ref: 78818 USE BSA-00480 SPACER SUITS HD150, EHD150, HD300B & EHD300 BSA-74808K Mounting bolt kit (4 bolts & nuts) BSA-100673 Beam to spacer bolt (require 2) BSA-100852 Beam to spacer nut (require 2)	812MM	N/A	130MM	10MM	N/A
BSA-00486	Nib style Beam / Head flat to suit 6 foot slasher OEM Ref: 78816 USE BSA-00479 SPACER SUITS HD180, EHD180 & EHD360 BSA-74808K Mounting bolt kit (4 bolts & nuts) BSA-100673 Beam to spacer bolt (require 2) BSA-100852 Beam to spacer nut (require 2)	1116MM	N/A	130MM	10MM	N/A
BSA-00489	Nib style Beam / Head flat to suit 7 foot slasher OEM Ref: 78814 USE BSA-00478 SPACER SUITS HD210 & EHD210 BSA-74808K Mounting bolt kit (4 bolts & nuts) BSA-100673 Beam to spacer bolt (require 2) BSA-100852 Beam to spacer nut (require 2)	1414MM	N/A	130MM	10MM	N/A

Beam length is from blade bolt hole centres

Beam length is from blade bolt hole centres

Beam length is from blade bolt hole centres

SPACER BEAMS

- BSA-00480** suit BSA-00484 Beams OEM 78734 (722 x 130 x 12mm)
- BSA-00479** suit BSA-00486 Beams OEM 78732 (1026 x 130 x 12mm)
- BSA-00478** suit BSA-00489 Beams OEM 78693 (1314 x 130 x 12mm)



BS-01572	Twisted double edge blade to suit 6' Left hand cut, OEM Ref: 73955, Bare-co B50 BSA-78299K Nib style bolt kit BSA-74222K Square shank bolt kit	432MM	32MM	75MM	12MM	N/A
----------	---	-------	------	------	------	-----



BS-01573	Twisted double edge blade to suit 5' Left hand cut, OEM Ref: 72900, Bare-co B6001 BSA-78299K Nib style bolt kit BSA-74222K Square shank bolt kit	280MM	32MM	75MM	12MM	N/A
----------	---	-------	------	------	------	-----



BS-01574	Stepped down double edge blade to suit 6', Hd240, EHDE300 & EHD360 TWIN L/H & R/H cut, OEM Ref: 74598A BSA-78299K Nib style bolt kit BSA-74222K Square shank bolt kit	355MM	32MM	75MM	12MM	40MM
----------	---	-------	------	------	------	------

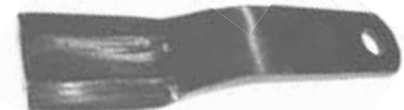

Part Number	Description	LENGTH	HOLE	WIDTH	THICK	STEP
BS-01724 LEFT HAND	Suction lift blade to suit 5', 6' & 7' Nugget & HD etc OEM Ref: 78663, Bare-co B6002	355MM	32MM	75MM	12MM	40MM
BS-01724R RIGHT HAND	BSA-78299K Nib style bolt kit (Inc. Bush) BSA-74222K Square shank bolt kit (Inc. Bush) BSA-09321 Hex Bolt Kit suit Nugget etc (Inc. Bush) BSA-00179 Bush	355MM	32MM	90MM	12MM	40MM
BS-08743	Leading Edge blade alternative Left hand cut, OEM Ref: 78787, Bare-co B6004	355MM	32MM	90MM	12MM	40MM
BS-09281	H/Duty blade suit EHD240 & EHD240E, XHD240 Left hand cut, OEM Ref: 613400 & 613400KN - Kit	510MM	32MM	100MM	12MM	45MM
BS-09281K Blade & Nib Bolt Kit	BSA-09281K Blade & Nib bolt kit (includes 2ea) BSA-78299K Nib style bolt kit (Inc. Bush) BSA-00179 Bush					
BS-78663K Blade & Nib Bolt Kit	Suction lift blade kit to suit 5', 6' & 7' slashers with Nib Style Beams HS130/150, NUG150/180 & HD Left hand cut, OEM Ref: 78663KN KIT INCLUDES 2 X BS-01724 BLADES & 2 X BSA-78299K NIB BOLT KITS	355MM	32MM	75MM	12MM	40MM
BS-78663KHEX Blade & Hex Head Bolt Kit	Suction lift blade kit to suit NUGGET 120, 135, 150L, 150, 180 & 210 & MD120B, Nug120, HS30 Left hand cut, OEM Ref: 78663KH KIT INCLUDES 2 X BS-01724 BLADES & 2 X Hex Head Bolts, Bushes & Nyloc Nuts	355MM	32MM	75MM	12MM	40MM
BS-08743K Blade & Nib Bolt Kit	Leading Edge blade kit alternative Left hand cut, OEM Ref: 78787KN Suits HD & EHD 150, 180 & 210 KIT INCLUDES 2 X BS-08743 BLADES & 2 X BSA-78299K NIB BOLT KITS	355MM	32MM	90MM	12MM	40MM

IRONCRAFT / TITAN

Part Number	Description	LENGTH	HOLE	WIDTH	THICK	STEP
BS-08138 Right Hand Cut	Stepped & Fluted blade .15 Foot Titan BSA-09383 Bolt & Nut	571MM	38MM	100MM	13MM	58MM
BS-08139 Left Hand Cut	BS-08138 is Right Hand cut BS-08139 is Left Hand cut					
BS-09075	Stepped & Fluted blade - Suits Titan12 Foot deck - Centre Blade Left Hand cut Use BSA-09383 Bolt & Nut	563MM	38MM	75MM	12MM	58MM
BS-09381 Left Hand Cut	Stepped & Fluted blade. Suits 12 Foot Titan deck wings. Use BSA-09383 Bolt & Nut	405MM	38MM	75MM	12MM	58MM
BS-09382 Right Hand Cut	BS-09381 is Left Hand BS-09282 is Right Hand					
BSA-09383	Titan Blade Bolt & Nut Square shank bolt, washer & nut					

Part Number	Description	LENGTH	HOLE	WIDTH	THICK	STEP
BS-01075	Heavy Duty stepped down blade to suit 6' Left hand cut, OEM Ref: 21353 Can use BS-07805 Suction Lift Style Blade. Bolts are not available, they are Genuine only.	560MM	45MM	100MM	13MM	45MM
BS-01583	Suction Lift blade to suit 4' to 6' slashers Left hand cut, OEM Ref: 21003, Bare-co B6000 BSA-00178 BUSH BSA-100675 BOLT BSA-100852 NUT	490MM	32MM	75MM	10MM	45MM
BS-01582	Standard step down blade to suit 1mtr & 4' Left hand cut, OEM Ref: 21010 BSA-21008 BOLT (3/4" Thread) BSA-100852 NUT	275MM	25MM	65MM	7MM	38MM

KANGA

Part Number	Description	LENGTH	HOLE	WIDTH	THICK	STEP
BS-00467	Twisted double edge blade to suit S, M, H & XH Left hand cut, OEM Ref: 21016 BSA-06394B BUSH BSA-07453K BOLT & NUT KIT (1 bolt & 1 nut)	330MM	38MM	100MM	10MM	N/A
BS-01724	Suction Lift blade to suit 6' & 7' etc Left hand cut - Replaces OEM 100-134, ASP blade has different hole size - Must use with fasteners below: OPTION 1 BSA-00179 3/4" ID BUSH BSA-100675 3/4" HEX BOLT BSA-100852 3/4" NUT OPTION 2 BSA-00190 7/8" ID BUSH OEM REF 100-136 BSA-07453K 7/8" HEX BOLT / NUT OPTION 3 BSA-09027 C/SUNK, SQUARE SHANK BOLT KIT OEM REF 100-135	355MM	32MM	75MM	12MM	40MM

LOXTON

Part Number	Description	LENGTH	HOLE	WIDTH	THICK	STEP
BS-07652	Flat double edge blade LH & RH cut, OEM Ref: SL056 BSA-07659 BUSH BSA-07658 BOLT KIT (1 x bolt, nut & bracket)	238MM	23MM	65MM	8MM	N/A
BS-07615	Standard step down double edge blade LH & RH cut, OEM Ref: SL057 BSA-07659 BUSH BSA-07658 BOLT KIT (1 x bolt, nut & bracket)	238MM	23MM	65MM	8MM	22MM
BS-07653 RIGHT HAND	Suction Lift blade Right hand cut, OEM Ref: SLP054 Left hand cut, OEM Ref: SLP055	238MM	23MM	65MM	8MM	15MM
BS-07654 LEFT HAND	BSA-07659 BUSH BSA-07658 BOLT KIT (1 x bolt, nut & bracket)					

Part Number	Description	LENGTH	HOLE	WIDTH	THICK	STEP
BS-09339	Major Cyclone MJ30 - 280, 350, 420 & 560 Overlap Blade OEM Ref BLD25025-OVL Use with: BSA-09340 BOLT, BSA-09341 BUSH, BSA-09342 DISC SPRING WASHER (2 PER BLADE) & BSA-09363 NYLOC NUT.	175MM	25MM	75MM	8MM	
BS-09343	Major Cyclone MJ30 - 280, 350, 420 & 560 Left Hand Cut Step blade OEM 27025T-10AC Use with: BSA-09345 BLADE BOLT, BSA-09363 NYLOC NUT, BSA-09346 BUSH, BSA-09342 DISC SPRING WASHER (2 PER BLADE REQUIRED)	235MM	25MM	80MM	10MM	
BS-09344	Major Cyclone MJ30 - 280, 350, 420 & 560 Right Hand Cut blade OEM 27025T-10C Use with: BSA-09345 BLADE BOLT, BSA-09363 NYLOC NUT, BSA-09346 BUSH, BSA-09342 DISC SPRING WASHER (2 PER BLADE REQUIRED)	235MM	25MM	80MM	10MM	
BS-09348	Major Cyclone MJ30 - 200 & 250 Left Hand Cut Step blade OEM 25025T-10AC NEW Use with: BSA-09345 BLADE BOLT, BSA-09363 NYLOC NUT, BSA-09346 BUSH, BSA-09342 DISC SPRING WASHER (2 PER BLADE REQUIRED)	213MM	25MM	80MM	10MM	
BS-09349	Major Cyclone MJ30 - 200 & 250 Right Hand Cut blade OEM 25025T-10C NEW Use with: BSA-09345 BLADE BOLT, BSA-09363 NYLOC NUT, BSA-09346 BUSH, BSA-09342 DISC SPRING WASHER (2 PER BLADE REQUIRED)	213MM	25MM	80MM	10MM	

McLEOD / MF

Part Number	Description	LENGTH	HOLE	WIDTH	THICK	STEP
BS-01075	Heavy Duty stepped down blade to suit 6' Left hand cut BSA-01074 BUSH BSA-700427 1" PIN BSA-700430 NUT	560MM	45MM	100MM	13MM	45MM
BS-07805	Suction lift blade to suit 6' Left hand cut BSA-01074 BUSH BSA-700427 1" PIN BSA-700430 NUT	560MM	45MM	100MM	13MM	45MM
BS-00986	Stepped down blade to suit 5' Left hand cut BSA-01073 BUSH BSA-700419 7/8" PIN BSA-700423 NUT	495MM	35MM	75MM	13MM	40MM
BS-1138	Heavy Duty stepped down blade to suit 5' Left hand cut BSA-01074 BUSH BSA-700427 1" PIN BSA-700430 NUT	495MM	45MM	100MM	13MM	45MM
BS-07161	Stepped down Double edge blade to suit 4' Left & Right hand cut BSA-07161B BUSH BSA-700419 7/8" PIN BSA-700423 NUT	331MM	38MM	100MM	10MM	47MM

Part Number	Description	LENGTH	HOLE	WIDTH	THICK	STEP
Fasteners to suit McLeod with 7/8" PIN						
BSA-700420	CUP	BSA-700419	7/8" PIN	<p>CUP (Recessed for Dome Head Pin)</p> <p>BOSS (welded to top of disc, with KEY slot)</p> <p>Clutch Disc</p> <p>PIN (Dome head with KEY slot)</p>		
BSA-700421	BOSS	BSA-700423	7/8" NUT			
BSA-701962	KEY	BSA-01073	BUSH			
BSA-700494	CLUTCH DISC 151mm X 57mm X 4.7mm THICK					
Fasteners to suit McLeod with 1" PIN						
BSA-700428	CUP	BSA-700427	1" PIN			
BSA-700431	BOSS	BSA-700430	1" NUT			
BSA-701962	KEY	BSA-01074	BUSH			
BSA-700494	CLUTCH DISC 151mm X 57mm X 4.7mm THICK					

Slasher Blades are measured from the centre of the bolt hole to the end of the blade.

SCHULTE

Part Number	Description	LENGTH	HOLE	WIDTH	THICK	STEP
BS-09428	Stepped & Fluted blade suit 6 & 7ft decks OEM Ref 401-039 Right Hand cut	714MM	38MM	100MM	13MM	65MM
NEW						
BS-08141	Stepped & Fluted blade suit Fx520 etc Left Hand cut, OEM Ref 401-048A, 401-028 (Can use with BS-08959 flat blade)	645MM	38MM	100MM	13MM	58MM
LEFT HAND						
BS-09412	Stepped & Fluted blade suit FX520 etc Left Hand cut, OEM Ref 401-068 (Can use with BS-09414 flat blade)	457MM	38MM	100MM	13MM	58MM
RIGHT HAND						
NEW						
BS-09413	Stepped & Fluted blade suit FX520 etc Left Hand cut, OEM Ref 401-067 (Can use with BS-09414 flat blade)	457MM	38MM	100MM	13MM	58MM
LEFT HAND						
NEW						
BS-09414	Mulch Blade. Flat double edge for both Left & Right hand cut, Use with BS-09412 & BS-09413 blades. 457mm LONG, 75mm WIDE X 10mm THICK, 38mm hole. OEM Ref					
NEW						
BS-08959	Mulch Blade. Flat double edge for both Left & Right hand cut, Use with BS-08140 & BS-08141 blades. 645mm LONG, 75mm WIDE X 10mm THICK OEM Ref 401-034					
OEM Ref 401-034						
BS-09088	Mulch Blade. Flat double edge for both Left & Right hand cut, Use with BS-08138 & BS-08139 blades. 571mm LONG, 75mm WIDE X 10mm THICK					
OEM Ref 401-033						

Part Number	Description	LENGTH	HOLE	WIDTH	THICK	STEP
BS-08138 RIGHT HAND	Stepped & Fluted blade, Right Hand cut, OEM Ref 401-046A, 401-026 <i>(can use with BS-09088 Flat Blade)</i>	571MM	38MM	100MM	13MM	58MM
BS-08139 LEFT HAND	Stepped & Fluted blade, Left Hand cut, XH1500 OEM Ref 401-047A, 401-027 <i>(can use with BS-09088 Flat Blade)</i>	571MM	38MM	100MM	13MM	58MM
BS-08140 RIGHT HAND	Stepped & Fluted blade. Right Hand cut, XH1500 OEM Ref 401-049A, 401-032, 401-052 <i>(Can use with BS-08959 flat blade)</i>	645MM	38MM	100MM	13MM	58MM
BS-08141 LEFT HAND	Stepped & Fluted blade Left Hand cut, OEM Ref 401-048A, 401-028 <i>(Can use with BS-08959 flat blade)</i>	645MM	38MM	100MM	13MM	58MM
BSA-09094 BOLT & NUT	Bolt & Nut suit double blade mulch blade set up on Schulte slashers. 5 side Pentagon shank. Bolt has a 7/8" shank to suit the 2 blades. Will not suit single blade set up. OEM Ref 251-019, 251-203					

SUPERIOR & PAGE

Part Number	Description	LENGTH	HOLE	WIDTH	THICK	STEP
BS-01586	Standard step down double edge blade LH & RH cut, OEM Ref: S3608 BSA-00175 BUSH BSA-08089 BOLT KIT <i>(bolt kit includes 1x bolt, bush & nut)</i>	250MM	25MM	65MM	7MM	22MM
BS-P1927	Flat reversible blade Left hand cut, OEM Ref: S2427 BSA-00178 BUSH BSA-08042 BOLT KIT <i>(bolt kit includes 1x Dome head bolt, bush & nut)</i>	305MM	32MM	75MM	10MM	N/A
BS-P1938/10	Standard step down double edge blade LH & RH cut, OEM Ref: S4065, P1938 BSA-00178 BUSH BSA-08042 BOLT KIT <i>(bolt kit includes 1x Dome head bolt, bush & nut)</i>	305MM	32MM	75MM	10MM	40MM
BS-01599	Flat reversible blade to suit 5' Left hand cut, OEM Ref: S4062, P1502 BSA-00180 BUSH BSA-S2115K BOLT KIT <i>(bolt kit includes 1x Dome head bolt, bush & nut)</i>	305MM	32MM	75MM	16MM	N/A
BS-00797	Standard step down double edge blade to suit 5' LH & RH cut, OEM Ref: S4600, P4073 BSA-00180 BUSH BSA-S2115K BOLT KIT <i>(bolt kit includes 1x Dome head bolt, bush & nut)</i>	305MM	32MM	75MM	16MM	40MM

Part Number	Description	LENGTH	HOLE	WIDTH	THICK	STEP
BS-01601 LEFT HAND	Suction lift blade to suit 5' & Multi Gearbox Left hand cut, OEM Ref: S4064, P1503, S4090 BSA-00180 BUSH BSA-S2115K BOLT KIT (bolt kit includes 1x Dome head bolt, bush & nut)	305MM	32MM	75MM	16MM	40MM
BS-01601R RIGHT HAND	Suction lift blade to suit 5' & Multi Gearbox Right hand cut, OEM Ref: S4091 BSA-00180 BUSH BSA-S2115K BOLT KIT (bolt kit includes 1x Dome head bolt, bush & nut)	305MM	32MM	75MM	16MM	40MM
BS-S2428	Flat reversible blade to suit 6' Left hand cut, OEM Ref: S2428 BSA-00178 BUSH BSA-08042 BOLT KIT (bolt kit includes 1x Dome head bolt, bush & nut)	460MM	32MM	75MM	10MM	N/A
BS-P2028	Standard step down double edge blade to suit 6' LH & RH cut, OEM Ref: S6064, P2028, S2424 BSA-00178 BUSH BSA-08042 BOLT KIT (bolt kit includes 1x Dome head bolt, bush & nut)	460MM	32MM	75MM	10MM	40MM
BS-01600	Flat reversible blade to suit 6' & 7' Left hand cut, OEM Ref: S5062, P1584, P4098 BSA-00180 BUSH BSA-S2115K BOLT KIT (bolt kit includes 1x Dome head bolt, bush & nut)	460MM	32MM	75MM	16MM	N/A
BS-01602 LEFT HAND	Suction Lift blade to suit 6' & 7' Left hand cut, OEM Ref: S5064, S5061, P1585 BSA-00180 BUSH BSA-S2115K BOLT KIT (bolt kit includes 1x Dome head bolt, bush & nut)	460MM	32MM	75MM	16MM	40MM
BS-01602R RIGHT HAND	Suction Lift blade to suit 6' & 7' Right hand cut, OEM Ref: S5065, S2116 BSA-00180 BUSH BSA-S2115K BOLT KIT (bolt kit includes 1x Dome head bolt, bush & nut)	460MM	32MM	75MM	16MM	40MM
BS-01603	Standard step down blade to suit 6' & 7' Left hand cut, OEM Ref: S5063 BSA-00180 BUSH BSA-S2115K BOLT KIT (bolt kit includes 1x Dome head bolt, bush & nut)	460MM	32MM	75MM	16MM	40MM
BS-01604	Standard step down double edge blade to suit 6' & 7' LH/RH cut, OEM S2142, P4099 Bare-co B6999 BSA-00180 BUSH BSA-S2115K BOLT KIT (bolt kit includes 1x Dome head bolt, bush & nut)	460MM	32MM	75MM	16MM	40MM
BS-01606	Large step down double edge blade to suit 6' & 7' LH & RH cut, OEM Ref: S2143, S2164 BSA-00180 BUSH BSA-S2115K BOLT KIT (bolt kit includes 1x Dome head bolt, bush & nut)	460MM	32MM	75MM	16MM	75MM

Part Number Description

Beam length is from centre of blade bolt holes
LENGTH HOLE WIDTH THICK STEP

PLEASE NOTE: ALL BEAM LENGTH MEASUREMENTS ARE TAKEN FROM THE CENTRE OF THE BLADE BOLT HOLES...NOT AN OVERALL LENGTH. PLEASE CHECK MOUNTING HOLE CENTRES.

BSA-S4058 Superior beam / head flat to suit 4' & 4'6" with round holes. 20mm mounting bolt holes @ 152mm centres.
BSA-S3393 MOUNTING BOLT (require 2)
BSA-100852 NUT (require 2)

609MM N/A 75MM 10MM N/A



BSA-S2112 Superior beam / head flat to suit 4' & 4'6" with square holes. 20mm mounting bolt holes @ 152mm centres.
BSA-S3393 MOUNTING BOLT (require 2)
BSA-100852 NUT (require 2)

609MM N/A 75MM 10MM N/A



BSA-S6058 Superior beam / head flat to suit 6' with round holes. 20mm mounting bolt holes @ 152mm centres. (USE BSA-S6081 SPACER BEAM)
BSA-S3393 MOUNTING BOLT (require 2)
BSA-100852 NUT (require 2)

OEM REF:
 S6058
 S6054 (8mm THICK)

916MM N/A 75MM 10MM N/A



Beam Bolt & Nut: BSA-100675 Bolt & BSA-100852 Nut

BSA-S2113 Superior beam / head flat to suit 6' with square holes. 20mm mounting bolt holes @ 152mm centres. (USE BSA-S6081 SPACER BEAM)
BSA-S3393 MOUNTING BOLT (require 2)
BSA-100852 NUT (require 2)

OEM REF:
 S2113
 S6056

916MM N/A 75MM 10MM N/A



Beam Bolt & Nut: BSA-100675 Bolt & BSA-100852 Nut

BSA-S7058 Superior beam / head flat to suit 7' with round holes. 20mm mounting bolt holes @ 152mm centres. (USE BSA-S7059 SPACER BEAM)
BSA-S3393 MOUNTING BOLT (require 2)
BSA-100852 NUT (require 2)

OEM REF:
 S7058
 S7047

1221MM N/A 75MM 10MM N/A



Beam Bolt & Nut: BSA-100675 Bolt & BSA-100852 Nut

BSA-S7060 Superior beam / head flat to suit 7' with square holes. 20mm mounting bolt holes @ 152mm centres. (USE BSA-S7059 SPACER BEAM)
BSA-S3393 MOUNTING BOLT (require 2)
BSA-100852 NUT (require 2)

OEM REF:
 S7060
 S7038

1221MM N/A 75MM 10MM N/A



Beam Bolt & Nut: BSA-100675 Bolt & BSA-100852 Nut

BSA-S6081 SUPERIOR BEAM SPACERS - 16MM THICK (Spacers suit 16mm thick Superior Blades)
BSA-S6081 SUIT 6 FOOT (790mm Long)
BSA-S7059 SUIT 7 FOOT (1090mm Long) (20mm bolt holes @ 152mm centres)

6 FOOT

7 FOOT



Beam Bolt & Nut: BSA-100675 Bolt & BSA-100852 Nut

PLEASE NOTE: THE FOLLOWING ARE PAGE BEAMS...NOT SUPERIOR. PLEASE CHECK HOLE SIZES AND HOLE CENTRES.

BSA-1496 Page beam / head flat to suit 6' with round holes. 16.5mm mounting bolt holes @ 146mm centres. USE BSA-1383 SPACER BEAM

PAGE BEAM 6 FOOT

916MM N/A 75MM 10MM N/A



BSA-4411 Page beam / head flat to suit 6' with square holes. 16.5mm mounting bolt holes @ 146mm centres. USE BSA-1383 SPACER BEAM

PAGE BEAM 6 FOOT

916MM N/A 75MM 10MM N/A



Part Number	Description	LENGTH	HOLE	WIDTH	THICK	STEP
BSA-5496 PAGE BEAM 7 FOOT	Page beam / head flat to suit 7' with <u>round holes</u> . 16.5mm mounting bolt holes @ 146mm centres. (USE BSA-4597 SPACER BEAM)	1221MM	N/A	75MM	10MM	N/A
BSA-5411 PAGE BEAM 7 FOOT	Page beam / head flat to suit 7' with <u>square holes</u> . 16.5mm mounting bolt holes @ 146mm centres. (USE BSA-4597 SPACER BEAM)	1221MM	N/A	75MM	10MM	N/A
BSA-1383 6 FOOT PAGE	Page Spacer Beams- (Suits 16mm Thick Page Blades) BSA-1383 SUIT 6 FOOT (790mm Long)					
BSA-4597 7 FOOT PAGE	BSA-4597 SUIT 7 FOOT (1090mm Long) (16.5mm bolt holes @ 146mm centres)					
BSA-08043	Hex head bolt kit alternative to suit 8mm & 10mm thick blades (1x high tensile bolt, bush & lock nut).					
BSA-08044	Hex head bolt kit alternative to suit 16mm thick blades (1x high tensile bolt, bush & lock nut).					
BSA-08042	Dome head bolt kit to suit 8 & 10mm thick blades (1x Dome head bolt, bush & lock nut). Includes: BSA-00178 BUSH x 1 BSA-S2115M BOLT x 1 BSA-PG1113 NUT x 1					
BSA-S4027	SUPERIOR CLUTCH DISC Also 8" Bareco Slip clutches incl. 4 & 6 plate Ref B3721 165mm x 64mm x 3.2mm thick.					
BSA-S2115K	Dome head bolt kit to suit 16mm thick blades (1x Dome head bolt, bush & lock nut). Includes: BSA-00180 BUSH x 1 BSA-S2115 BOLT x 1 BSA-PG1113 NUT x 1					
BSA-S2114	3/4 X 2 7/8" DOME HEAD BOLT ONLY (USE WITH BSA-00180 BUSH & BSA-PG1113 NUT)					
BSA-S8127	3/4 X 3 1/2" DOME HEAD BOLT ONLY (USE WITH BSA-00180 BUSH & BSA-PG1113 NUT)					

WARATAH / SILVAN

Part Number	Description	LENGTH	HOLE	WIDTH	THICK	STEP
BS-07453	Standard step down blade Left hand cut (Note: Double Cutting Edge style coming soon) BSA-07161B BUSH BSA-07453K BOLT KIT (bolt kit includes 1x bolt & nut)	331MM	38MM	75MM	8MM	47MM
BS-07161	Heavy Duty step down blade DOUBLE EDGE STYLE - OEM Ref WKB2 BSA-07161B BUSH BSA-07453K BOLT KIT (bolt kit includes 1x bolt & nut)	331MM	38MM	100MM	10MM	47MM

Part Number	Description	LENGTH	HOLE	WIDTH	THICK	STEP
BS-08138 R/H	Stepped & Fluted blade . BATWING BW180X BS-08138 is Right Hand cut	571MM	38MM	100MM	13MM	58MM
BS-08139 L/H	BS-08139 is Left Hand cut					
BS-09076	Stepped & Fluted blade - Suits select Woods deck - check sizes Left Hand cut (Woods blade Pin NOT available)	714MM	38MM	100MM	13MM	65MM



SLASHER - UNIVERSAL

Part Number	Description	LENGTH	HOLE	WIDTH	THICK	STEP
BS-08959	Universal Blade Flat double edge for both Left & Right hand cut, extra long 350mm cutting edge allows for blade to be cut down. Use BSA-06394B, BSA-00191 or BSA-00192 bushes depending on bolt size.	645MM	38	75MM	10MM	
BS-09251	Universal Blade Step (40mm) double edge for both Left & Right hand cut, extra long 340mm cutting edge allows for blade to be cut down. Use BSA-06394B, BSA-00191 or BSA-00192 bushes depending on bolt size.	645MM	38	75MM	10MM	40MM



ASP CASE HARDENED SLASHER BLADE BUSHES - QUICK REFERENCE CHART

Part Number	O/D	I/D	Thick	Part Number	O/D	I/D	Thick
BSA-01074	44.5	25.4	14	BSA-00190	31.5	22.5	14
BSA-00193	37.5	22.5	14	BSA-09385	31.5	22.5	11
BSA-07161B	37.5	22.5	13	BSA-00180	31.5	20	17
BSA-06394B	37.5	22.5	11	BSA-00179	31.5	19.5	14
BSA-02003B	37.5	19.5	14	BSA-00178	31.5	19.5	11
BSA-00191	37.5	19.5	11	BSA-01981B	24.5	19.5	11
BSA-00192	37.5	16.5	11	BSA-04457B	24.5	19.5	9
BSA-01073	34.5	22.5	14	BSA-00175	24.5	16.5	9
				BSA-07659	22.5	16.5	10

Notes:

SLASHER BLADE SIZE CHART

Part #	Brand	Length	Width	Thick	Hole	Step	Profile
BS-09339	Major	185	75	8	25		Angled
BS-09348	Major	213	80	10	25		Angled
BS-09349	Major	213	80	10	25		Angled
BS-09343	Major	235	80	10	25		Angled
BS-09344	Major	235	80	10	25		Angled
BS-07652	Loxton	238	65	8	23		Flat
BS-07615	Loxton	238	70	8	23	22	Step
BS-07654	Loxton	238	70	8	23	15	Step
BS-07653	Loxton	238	70	8	23	15	Step
BS-01586	Gessner	250	65	7	25	22	Step Double Edge
BS-09046 / 47	Chris Grow / Gason	250	100	10	32	70	Suction Lift
BS-09050 / 51	Chris Grow / Gason	250	100	13	32	70	Suction Lift
BS-04457	Berends	262	65	8	26	25	Step L/H
BS-01582	Jarrett	275	65	7	25	38	Suction Lift L/H
BS-01573	Howard	280	75	12	32	0	Flat Twisted End L/H
BS-P1938/10	Superior / Page	305	75	10	32	40	Step Double Edge
BS-P1927	Superior / Page	305	75	10	32	0	Flat L/H
BS-01599	Superior / Page	305	75	16	32	0	Flat L/H
BS-00797	Superior / Page	305	75	16	32	40	Step Double Edge
BS-01605	Superior / Page	305	75	16	32	40	Step L/H
BS-01601	Superior / Page	305	75	16	32	40	Suction Lift L/H
BS-00467	Daken	330	100	10	38	15	Flat Twisted End L/H
BS-07161	Waratah	331	100	10	38	47	Step Double Edge
BS-07453	Waratah	331	75	8	38	47	Step L/H
BS-09271	Digga	350	100	13	38	40	Step Double Edge
BS-09044	Chris Grow / Gason	350	100	13	32	40	Step Double Edge
BS-01724	Howard	355	75	12	32	40	Suction L/H
BS-01724R	Howard	355	75	12	32	40	Suction R/H
BS-08743	Howard	355	90	12	32	40	Suction L/H
BS-01574	Howard	355	75	12	32	40	Step Double Edge
BS-08922 / 23	Chris Grow / Gason	357	100	10	32	70	Suction Lift
BS-08226 / 27	Chris Grow / Gason	357	100	13	32	60	Suction Lift
BS-09416	Berends	368	75	10	32	25	Step Double Edge
BS-01981	Berends	368	75	10	26		Flat L/H

**SLASHER BLADE LENGTH IS MEASURED
FROM CENTRE OF HOLE**

SLASHER BLADE SIZE CHART - Cont.

Part #	Brand	Length	Width	Thick	Hole	Step	Profile
BS-09381	Ironcraft / Titan	405	75	12	38	58	Step & Fluted Lh
BS-09382	Ironcraft / Titan	405	75	12	38	58	Step & Fluted Rh
BS-09264	Himac	415	100	12	38	65	Step Double Edge
BS-01572	Howard	432	75	12	32		Flat Twisted End L/H
BS-08228 / 29	Chris Grow / Gason	450	100	13	32	65	Suction Lift
BS-09045	Chris Grow / Gason	450	100	13	32	50	Step Double Edge
BS-09048 / 49	Chris Grow / Gason	450	100	10	32	75	Suction Lift
BS-09412	Schulte	457	100	13	38	58	Suction Lift R/H
BS-09413	Schulte	457	100	13	38	58	Suction Lift L/H
BS-09414	Schulte	457	75	10	38		Flat Double Edge
BS-01600	Superior / Page	460	75	16	32		Flat L/H
BS-01602	Superior / Page	460	75	16	32	40	Suction Lift L/H
BS-01602R	Superior / Page	460	75	16	32	40	Suction Lift R/H
BS-01603	Superior / Page	460	75	16	32	40	Step L/H
BS-01604	Superior / Page	460	75	16	32	40	Step Double Edge
BS-01606	Superior / Page	460	75	15	32	75	Step Double Edge
BS-S2428	Superior / Page	460	75	10	32		Flat L/H
BS-P2028	Superior / Page	460	75	10	32	40	Step Double Edge
BS-02003	Berends	460	100	12	38	25	Step L/H
BS-01583	Jarrett	490	75	10	32	45	Suction Lift L/H
BS-02000	Berends	495	75	10	32	25	Step Double Edge
BS-01585	Berends	495	75	10	32		Flat L/H
BS-1138	Mcleod	495	100	13	45	45	Step L/H
BS-00986	Mcleod	495	75	13	35	40	Step L/H
BS-09366	Himac	495	75	10	32	55	Suction Lift L/H
BS-09281	Howard	510	100	12	32	45	Suction Lift L/H
BS-01075	Mcleod	560	100	13	45	45	Step L/H
BS-07805	Mcleod	560	100	13	45	45	Step & Fluted L/H
BS-09075	Woods / Titan	563	75	12	38	58	Step & Fluted L/H
BS-08959	Universal	645	75	10	38		Flat Double Edge
BS-09251	Universal	645	75	10	38	40	Step Double Edge
BS-08138	Schulte	571	100	13	38	58	Stepped & Fluted R/H
BS-08139	Schulte	571	100	13	38	58	Stepped & Fluted L/H
BS-08140	Schulte	645	100	13	38	58	Stepped & Fluted R/H
BS-08141	Schulte	645	100	13	38	58	Stepped & Fluted L/H
BS-09076	Fieldquip	714	100	13	38	65	Stepped & Fluted L/H
BS-09428	Schulte	714	100	13	38	65	Stepped & Fluted R/H

**SLASHER BLADE LENGTH IS MEASURED
FROM CENTRE OF HOLE**



MULCHING HAMMERS & FLAILS



HAMMER



FLAIL



ASP Cast hammers and ground tools are manufactured using a Nickel Chromium Molybdenum Alloy similar to that used in the mining industry for bucket teeth on heavy earth moving equipment. ASP Flails are made in Europe from Boron steel.

ASP offers a huge range of parts delivered Australia wide with same day despatch on all stocked items for orders received prior to 2pm.

Check out our website:
www.asproducts.com.au

Part Number	Description	Diagram	HOLE	WIDTH	THICK	LENGTH from centre of hole
BS-06943 or BS-06943HF Hard Faced Option	Double edge 'Y' blade. OEM Ref A37094 AMM, ACM & AHM models BSA-09250 Bush - 55mm long OE A37070 BSA-06943B - 16mm thick Spacers OE A37071		25.4MM	60MM	10MM	171MM
			A= 204 B= 55			
CI-1401	Cast hammer flail. ASP401, OEM Ref A-37644 (EM08 with 16.5mm hole) CIA-08472 BOLT CIA-100850 NUT ASM models use CIA-08028 fastener kit					
			A= 120 B= 40 R= 90 16.5mm Hole			

AGRIMASTER

Part Number	Description	Diagram	HOLE	WIDTH	THICK	LENGTH from centre of hole
BS-08490	Double edge blade 'Y' blade OEM 300 0106		25.5MM	60MM	8MM	118MM
			A= 147 B= 62			
BS-08491	Flat double edge blade		25.5MM	60MM	8MM	118MM
			A= 147			
CI-11/20	Cast hammer flail OEM Ref 30011 Suits FA 175,200 & 225 Bolt & Nut CIA-08330 EM31					
			A= 150 B= 60 R= 90 20.5mm Hole			

ALPEGO

Part Number	Description	Diagram	HOLE	WIDTH	THICK	LENGTH from centre of hole
CI-08682	Cast hammer flail OEM Ref MK0A00212. P40061 (EM06 with 18.5mm hole)					
			A= 137 B= 40 R= 95 18.5mm Hole			

BERENDS (JBI)

Part Number	Description	Diagram	HOLE	WIDTH	THICK	LENGTH from centre of hole
BS-08001	Double edge blade 'Y' blade Suits pre 2000 mulchers OEM Ref: 1600 use with bolt & nut kit BSA-09081		20.5MM	50MM	10MM	120MM
			A= 138 B= 55			
BS-08471	Double edge 'L' blade OEM Ref: 1599 use with bolt & nut kit BSA-09081		20.5MM	50MM	10MM	120MM
			A= 138 B= 55			

PLEASE CHECK BLADE SIZES BEFORE ORDERING FLAILS & HAMMERS

Part Number	Description	Diagram	HOLE	WIDTH	THICK	LENGTH from centre of hole
BS-08291	Double edge blade 'Y' blade Suits HIGH body mulchers OEM Ref: 1609 use with bolt & nut kit BSA-09081		20.5MM A= 185 B= 55	50MM	10MM	165MM

BERTI

Part Number	Description	Diagram	HOLE	WIDTH	THICK	LENGTH from centre of hole
BS-08835	Double edge 'Y' blade suits TSB High body & King etc OEM Ref 6010F28 BSA-09103 Bush 40mm long CIA-08330 Bolt & Nut (120mm long) BSA-09327 Bush 45mm long CIA-09329 Bolt & Nut (90mm long) BSA-09328 Spacer 8mm Thick - use with flat blade		28.5MM A= 204 B= 55	60MM	10MM	171MM
BS-09117	Double edge Flat blade option		28.5MM	60MM	8MM	171MM

CI-06/16	Cast hammer flail, ASP0616, EM06 (with 16.5mm hole) suit AF Low body, TA/P & TA/M OEM Ref MP0008, 'P' type hammer CIA-08700 Hex Head Bolt Kit (Bolt & Nut)		A= 137 B= 40 R= 95 16.5mm Hole			
CI-08853 'M' type Mega Rotor	Cast hammer flail, ASP853 XPRO & XPRO/F & EHD.TFH/F & TFH/M, TFB/M, TBM/S & TFB Low Body. OEM Ref: MP0794, CIA-09322 BOLT KIT (Bolt & Nut)		A= 137 B= 84 R= 95 20mm Hole			
CI-08909 or CI-08909HF Hard Faced Option	Cast hammer flail. ASP909 'A' type suit: TFB, TFB/SB, EKR/S low body, TA/PF, TBM & TA/P OEM Ref Mp3922 CIA-08992 BOLT KIT (Bolt & Nut)		A= 137 B= 52 R= 95 19.5mm Hole			
CI-08496	Cast hammer flail - double edge 'T' type Eco forest, all ECF models with reversible hammers Md1950		A= 71 B= 80 R= 80 30mm Hole			

BOMFORD

Part Number	Description	Diagram				
CI-FMB003	Cast 'boot' flail. OEM Ref: 0295901 CIA-08031 2mm Collar 0280101 CIA-08029 Bolt Kit 0367525 (Bolt kit includes 1 x bolt, lock nut & washer)		A= 68 B= 12 C= 85 40mm wide cutting edge 16mm x 32mm hole			

Part Number	Description	Diagram		
CI-08773	Double edge 'T' flail. OEM Ref: 46399.01 CI-08776 Flail Kit (kit includes flail, collars & fasteners) CIA-08774 Bush (2 per flail) CIA-08775 Bolt Kit		A= 70 B= 38 R= 105 25.4mm Hole	

BREVIGLIERI

Part Number	Description	Diagram				
CI-06/16	Cast hammer flail, ASP0616 suit Flash SR, Turbo-T, Master & Super Master, OEM Ref 56123 EM06 (with 16.5mm hole)		A= 137 B= 40 R= 95 16.5mm Hole			
BS-06943 Or BS-06943HF Hard Faced Option	Double edge 'Y' blade OEM Ref 55002		25.4MM A= 204 B= 55	60MM	10MM	171MM

BUFFALO

Part Number	Description	Diagram	HOLE	WIDTH	THICK	LENGTH from centre of hole
BS-08719	Double edge 'Y' blade (Use with BSA-08097 bush to reduce hole dia to 17mm)		25.4MM	65MM	10MM	140MM A= 170 B= 50

CELLI

Part Number	Description	Diagram	HOLE	WIDTH	THICK	LENGTH from centre of hole
BS-06943 Or BS-06943HF Hard Faced Option	Double edge suit Scorpio etc 'Y' blade OEM Ref 703011 BSA-06943B 16mm thick Spacer BSA-09269 11.5mm thick spacer (Spacers are 2" OD, please check)		25.4MM	60MM	10MM	171MM A= 204 B= 55
BS-279003	Straight Double edge blade Note: Most models require a 125mm long, flat head bolt, which is only available as OEM					
BS-09290	Double edge 'Y' blade Suit Gemini & Mizar etc OEM Ref 702611 CIA-08028 90mm long Bolt & Nut		16.5MM	50MM	10MM	103MM A= 123 B= 53
BS-09291	Straight Double edge blade OEM Ref 702612		16.5MM	50MM	10MM	98MM

CELLI Cont.



BoronBlue™



Part Number	Description	Diagram		
CI-1400 CI-1400HF Hard Faced Option	Cast hammer flail. ASP400 suit Vega OEM Ref 704052 Em04 (with 16.5mm hole)		A= 120 B= 40 R= 110 16.5mm Hole	
CI-06/16	Cast hammer flail. ASP0616 suit Mizar EM06 (with 16.5mm hole) OEM Ref: 702605		A= 137 B= 40 R= 95 16.5mm Hole	
CI-09279	Cast hammer flail suit Taurus - some, please check sizes. EM04/19 (with 19.5mm hole) Note: Requires O/Size 32mm Head Bolt - Only available as Genuine		A= 120 B= 40 R= 110 19.5mm Hole	

Please check your Flail or Hammer dimensions to ensure correct fitment.
If in doubt, please contact ASP on 07 3881 3464
or email sales@asproducts.com.au

COSMAG

Part Number	Description	Diagram		
CI-11/20	Cast hammer flail - some models. Please check sizes. EM31 CIA-08330 Bolt & Nut (120mm long bolt)		A= 150 B= 60 R= 90 20.5mm Hole	

COSMO BULLY

Part Number	Description	Diagram		
CI-09403 NEW	Cast hammer flail suits SFM models. OEM Ref 17295		A= 97 B= 39 R= 95 16.5mm Hole	
CI-09404 NEW	Cast hammer flail suits BPF models. OEM Ref 17067 EM06/20		A= 137 B= 39 R= 95 20.5mm Hole	

FAE

Part Number	Description	Diagram		
CI-08989HF	Cast hammer flail H/duty Hard Faced Single edge OEM Ref 111120001		A= 70 B= 60 R= 80 31mm Hole	

Part Number	Description	Diagram		
CI-FMB14	Cast hammer flail Reversible OEM Ref 111120001		A= 70 B= 60 R= 80 31mm Hole	
CI-08996	Cast hammer flail EM32		A= 76 B= 22 R= 95 16.5mm Hole	

FALC

Part Number	Description	Diagram	HOLE	WIDTH	THICK	LENGTH from centre of hole	
BS-06943 Or BS-06943HF <i>Hard Faced Option</i>	Double edge 'Y' blade OEM Ref 43.01.51		25.4MM A= 204 B= 55	60MM	10MM	171MM	
BS-279005	Double edge 'L' blade		25.4MM A= 204 B= 47	60MM	10MM	171MM	
BS-279003	Double edge Flat blade		25.4MM	60MM	10MM	171MM	
CI-08942 Or CI-08942HF <i>Hard Faced Option</i>	Hammer Flail alternative for BS-06943 'Y' blades EM26		A= 115 B= 50 R= 171 25.5mm Hole				
CI-08999 Or CI-08999HF <i>Hard Faced Option</i>	Hammer Flail OEM Ref 66 00 00 EM40		A= 105 B= 54 R= 98 25.5mm Hole				
BSA-06943P BSA-06944P BSA-06944SP BSA-06943B BSA-09269	Flat head Threaded 1" Pin with Nut & Washers Flat head Split Pin style 1" Pin Split Pin suit BSA-06944P - 50mm long 16mm Thick Spacer Bush (2" OD & 1" ID) 11.5mm Thick Spacer Bush (used with Straight blade)						

FERRI

Part Number	Description	Diagram	HOLE	WIDTH	THICK	LENGTH from centre of hole	
BS-08490	Double edge blade 'Y' blade OEM 0901003 Suits MKD200/230/250/280		25.5MM A= 147 B= 62	60MM	8MM	115MM	
BS-08491	Flat double edge blade Suits MKD200/230/250/280						

Part Number	Description	Diagram	HOLE	WIDTH	THICK	LENGTH from centre of hole
BS-09039	Double edge 'Y' blade use BSA-09040 Bush, BSA-09041 End Spacer x 2 & BSA-09042K Bolt & Nut		25.4MM A= 153 B= 60	60MM	10MM	125MM

GESSNER / LOFTNESS

Part Number	Description	Diagram	HOLE	WIDTH	THICK	LENGTH from centre of hole
BS-09143HF	Hard Faced Double edge 'Y' blade		24MM A= 173 B= 50	60MM	8MM	150MM
	BSA-09144 U Bracket BSA-09145 Bush					

HAYES

Part Number	Description	Diagram	HOLE	WIDTH	THICK	LENGTH from centre of hole
CI-09384	Cast hammer flail EM37		A= 87 B= 40 R= 100 16.5mm HOLE			

HOWARD (KRONOS)

Part Number	Description	Diagram	HOLE	WIDTH	THICK	LENGTH from centre of hole
BM-181024	Single edge blade BMA-151002 Shackle BSA -09270 Spacer		16 x 36MM A= 98 B= 39	40MM	12MM	
BS-06943 Or BS-06943HF Hard Faced Option	Double edge 'Y' blade suit Alce & Kronos etc BSA-06944P Pin & Split pin BSA-06943B 16mm Spacer (2" OD) BSA-09269 11.5mm Spacer		25.4MM A= 204 B= 55	60MM	10MM	171MM
BS-279005	Double edge 'L' blade		A= 204 B= 47			
BS-279003	Double edge Flat blade		A= 204			
CI-08942 CI-08942HF Hard Faced Option	Hammer Flail alternative for BS-06943 'Y' blades suit Alce etc EM26		A= 115 B= 50 R= 171 25.4mm Hole			

**** PLEASE CHECK BLADE DIMENSIONS ****

JANKE



BoronBlue™



Part Number	Description	Diagram	HOLE	WIDTH	THICK	LENGTH from centre of hole
BS-Y90HF Hard Faced	Riveted 'Y' blade assembly use with BSA-Y90CC Bush & Fastener Kit (includes Bush, Bolt, Nut & 2 X washers)		20MM	65MM	10MM	145MM
			A= 170 B= 80 (total of both together)			



KRONE

Part Number	Description	Diagram	HOLE	WIDTH	THICK	LENGTH from centre of hole
BM-336003	Double edge blade 'Y' blade		14.5MM	40MM	5MM	115MM
			A= 134 B= 40			



KUBOTA

Part Number	Description	Diagram	HOLE	WIDTH	THICK	LENGTH from centre of hole
BS-09390 NEW	Double edge blade 'Y' blade		25.4MM	60MM	7MM	218MM
			A= 245 B= 60			



KUHN

Part Number	Description	Diagram	HOLE	WIDTH	THICK	LENGTH from centre of hole
BS-06943 Oem Ref 6060004 BS-06943HF Hard Faced Option	Double edge 'Y' blade. 6060004 BSA-06943P Threaded pin BSA-06943B 16mm Spacer BSA-09269 11.5mm Spacer BSA-06944P Split Pin style Bolt		25.4MM	60MM	10MM	171MM
			A= 204 B= 55			
CI-08942 CI-08942HF Hard Faced Option	Hammer Flail alternative for BS-06943 'Y' blades OEM Ref Jx136378. EM26		A= 115 B= 50 R= 171 25.4mm Hole			
BSA-06944P	Pin to suit 25.4mm hole complete with Spit Pin. 45 x 35mm Rectangle Head, 90mm Overall Length, 81mm to Split Pin Hole					
BSA-06944SP	BSA-06944SP Split Pin suit BSA-06944P - 50mm long.					



MALETTI

Part Number	Description	Diagram	HOLE	WIDTH	THICK	LENGTH from centre of hole
BS-08009	Double edge 'Y' blade (Comes supplied as 2 x BS-06943 flails & 1 x BSA-08097 bush) Check clearance from centre of mount to drum, requires min 32mm.		17MM	60MM	10MM	171MM
			A= 204 B= 55			



Part Number	Description	Diagram	HOLE	WIDTH	THICK	LENGTH from centre of hole
BS-08303	Double edge 'Y' blade OEM Ref: T40005142, Type E Suits CL, ML & MS models		25.5MM A= 210 B= 61	60MM	8MM	190MM
BS-09022	Flat blade option, T40005141))					
BS-08304	Double edge blade 'Y' blade to suit BA models OEM Ref: T21004040 (Requires 2 of BSA-00192 spacers)		16.5MM A= 136 B= 60	45MM	8MM	120MM
BS-08490	Double edge blade 'Y' blade to suit some models		25.5MM A= 147 B= 62	60MM	8MM	115MM
CI-1400 CI-1400HF Hard Faced Option	Cast hammer flail. ASP400 EM04 (with 16.5mm hole) T24004025 Suits BL & CR models		A= 120 B= 40 R= 110 16.5mm Hole			
CI-11/20	Cast hammer flail EM31 OEM Ref M03400410R		A= 150 B= 60 R= 90 20.5mm Hole			
CI-06/16	Cast hammer flail. ASP0616 EM06 (with 16.5mm hole) OEM Ref 21004030 CIA-08028 Bolt & Nut (90mm long from under the head)		A= 137 B= 40 R= 95 16.5mm Hole			

McCONNEL

Part Number	Description	Diagram	HOLE	WIDTH	THICK	LENGTH from centre of hole
CI-1387	CI-1387 Hammer F10 Head Double edge 'T' flail. (Note: will not suit F14 head)		A= 60 B= 38 R= 135 25.4mm Hole	40MM	6MM	90MM
CI-1387K	CI-1387K Flail Kit (Kit includes Flail, bush & fasteners)					
CI-09248	CIA-1387BK Fastener kit Only (includes 1 x bush, bolt & lock nut) OEM Ref: 73.14.366					
BS-09100	H/Duty Single sided Hammer option suit F10					
BS-09100	Double edge Y blade suit ROBOCUT mowers OEM 4000242 (44 required per set) BSA-09113 Bush / Spacer BSA-09114 Bolt & Nut		12.5MM A= 100 B= 45	40MM	6MM	90MM

MDB GREEN CLIMBER

Part Number	Description	Diagram	HOLE	WIDTH	THICK	LENGTH from centre of hole
CI-09062	Cast hammer flail Suits LV600 etc Mulcher EM37		A= 85 B= 40 R= 100 14.5mm Hole			

MDB GREEN CLIMBER Cont.



BoronBlue™



Part Number	Description	Diagram		
CI-09417	Cast hammer flail Suits F300 etc Mulcher CIA-09418 Bush (16OD x 10ID x 13mm) CIA-09275 Bolt & Nut M10 Bolt		A= 78 B= 13 R= 75 16.5mm Hole	

NEW

M.E.A.A.T

Part Number	Description	Diagram	HOLE	WIDTH	THICK	LENGTH from centre of hole
BS-06943	Double edge 'Y' blade Suits TS140, TS160 & TS300		25.4MM	60MM	10MM	171MM
BS-06943HF	Hard Faced Option		A= 204 B= 55			
BS-279005	Double edge 'L' blade					
BS-279003	Double edge Flat blade					
CI-08682	Cast hammer flail EM06 (with 18.5mm hole) Check hole size					A= 137 B= 40 R= 95 18.5mm Hole

MOTT

Part Number	Description	Diagram	HOLE	WIDTH	THICK	LENGTH from centre of hole
BM-100759HD	Double edge 'Y' blade BM-100761 Shackle (50mm long from centre of hole, 28mm wide inside) BMA-102670 Pin (11mm x 75mm) BMA-00026 Split pin		13 x 27MM	40MM	5MM	65MM
			A= 82 B= 39			

MURATORI

Part Number	Description	Diagram	HOLE	WIDTH	THICK	LENGTH from centre of hole
BS-08814	Double edge 'Y' blade OEM Ref: 12007800		20.5MM	40MM	10MM	97MM
			A= 110 B= 46			

MUTHING

Part Number	Description	Diagram	HOLE	WIDTH	THICK	LENGTH from centre of hole
CI-06/16	Cast hammer flail. ASP0616 EM06 (with 16.5mm Hole), OEM Ref Mu000306 CIA-08028 Bolt & Nut (90mm long from under the head, MU980416)					A= 137 B= 40 R= 95 16.5mm Hole

Part Number	Description	Diagram	HOLE	WIDTH	THICK	LENGTH from centre of hole
BS-06943	Double edge, 'Y' blade Suits BNU, BNG, NK, RM, P. OEM Ref: N2555004		25.4MM	60MM	10MM	171MM
BS-06943HF	Hard Faced Alternative		A= 204 B= 55			
BSA-06943P	Flat head Threaded 1" Pin with Nut & Washers					
BSA-06944P	Flat head Split Pin style 1" Pin					
BSA-06944SP	Split Pin to suit the BSA-06944P Pin - 55mm long					
BSA-06943B	16mm Thick Spacer Bush. 2" OD & 1" ID					
BSA-09269	11.5mm Thick Spacer Bush (used with Straight blade)					
BS-279005	Double edge 'L' blade					
BS-279003	Double edge Flat blade OEM Ref: N1551000		A= 204			
BS-1781000	Double edge 'Y' blade Suits BNE & TB OEM Ref: N1781000		16.5MM	40MM	8MM	110MM
CI-1400	Cast hammer flail. ASP400, EM04 (with 16.5mm hole) OEM Ref N1891002, Suits TBL, VK, VKE, VKD, VKR, WMU & BNE.		A= 120 B= 40 R= 110 16.5mm Hole			
CI-1400HF	Hard Faced Option					
CI-08926	H/Duty Hammer flail alternative to the BS-06943.					
CI-08942	Hammer Flail alternative for BS-06943 'Y' blades EM26 OEM Ref N2555002, N136378					
CI-08942HF	Hard Faced Option					
CI-09279	Cast hammer flail EM04/19 (with 19.5mm hole) Some models with 19.5mm hole - check as will not suit models with 20mm bolts		A= 120 B= 40 R= 110 19.5mm Hole			
CI-09396	Cast hammer flail EM04/20 (with 20.5mm hole) <i>Some models with 20.5mm hole - suit models using metric 20mm bolts</i>		A= 120 B= 40 R= 110 20.5mm Hole			
NEW						
CI-08999	Hammer Flail EM40 BV100PRO, 001394 <i>Requires longer bolt than BSA-06943P. Bolt OEM Only.</i>		A= 105 B= 54 R= 98 25.5mm Hole			
CI-08999HF	Hard Faced Option					

Please check your Flail or Hammer dimensions to ensure correct fitment.
If in doubt, please contact ASP on 07 3881 3464
or email sales@asproducts.com.au

NOREMAT

Part Number	Description	Diagram	Dimensions	Image
CI-09208	Cast hammer flail Use CIA-08774L Bushes x 2 CIA-09365 Bolt (120mm long) & Nut		A= 65 B= 58 R= 70 25.5mm Hole	



ASP has a select range of popular Hammers & Flails with either a High Carbon Chrome, fine grit Tungsten or new Diamond coating to the cutting edge, as an option.

Unlike the traditional application of tungsten grit hard facing, that is applied in a weld form, the ASP hard faced option is applied in a thin coating that does not reduce the cutting performance of the flail or hammer.

ORSI & PERUGINI

Part Number	Description	Diagram	Dimensions	Image
CI-08989	Cast hammer flail, single edge W Forrest models OEM Ref 00023109		A = 70 B = 60 R = 80 31mm Hole	
CI-08989HF	Hard Faced Option			
CI-08753	Cast hammer flail CIA-08028 Special Bolt set		A= 147 B= 54 R= 97 16.5mm Hole	
CI-09206	Cast hammer flail EM10 Comfort, Dynamic & Twice models OEM Ref 00023130		A= 146 B= 54 R= 100 20.5mm Hole	

SALIBA

Part Number	Description	Diagram	Dimensions	Image
CI-09293	Cast hammer flail EM08 / 20 (with 20.5mm hole) TLB series etc.		A= 120 B= 40 R= 90 20.5mm Hole	

SAUERBURGER

Part Number	Description	Diagram	HOLE	WIDTH	THICK	LENGTH from centre of hole	Image
BS-09028HF	Hard Faced Double edge 'Y' blade Use BSA-09034 Fastener kit (includes Pin, Bush & Roll Pins) or BSA-09103 Bush		29MM	60MM	6MM	180MM	
						A= 210 B= 45	

Part Number	Description	Diagram	HOLE	WIDTH	THICK	LENGTH from centre of hole
BS-08304	Double edge blade 'Y' blade to replace CI-1400 (Requires 2 of BSA-00192 spacers)		16.5MM A= 136 B= 60	45MM	8MM	120MM
CI-09293	Cast hammer flail EM08/20 with 20.5mm hole		A= 120 B= 40 R= 90 20.5mm Hole			
CIA-08028	Suits CI-1401 & CI-1400 Hammers Oversized hex head (27mm) & 5/8" diameter shank, 90mm long from under the head (65mm bare shank) with crush nut.					
CI-1401	Cast hammer flail, ASP401 EM08 (16.5mm hole), OEM Ref: 13002041, 15002041 CIA-08028 Special bolt set (OEM Ref: 13002075)		A= 120 B= 40 R= 90 16.5mm Hole			
CI-1400	Cast hammer flail ASP400 EM04 (with 16.5mm hole) OEM Ref: 13002001 CIA-08028 Special bolt set (OEM Ref: 13002075)		A= 120 B= 40 R= 110 16.5mm Hole			
CI-1400HF Hard Faced Option						
CI-09396	Cast hammer flail EM04/20 (with 20.5mm hole) <i>Some models with 20.5mm hole - suit models using metric 20mm bolts</i>		A= 120 B= 40 R= 110 20.5mm Hole			
NEW						
CI-08989	Cast hammer flail, single edge OPT240, Miniforst, Midiforst. DT, Superforst & Forst M		A= 70 B= 60 R= 80 31mm Hole			
CI-08989HF Hard Faced Option						
CI-FMB14	Cast hammer flail Reversible OEM Ref: 11001008		A= 70 B= 60 R= 80 31mm Hole			

SICMA

Part Number	Description	Diagram	HOLE	WIDTH	THICK	LENGTH from centre of hole
BS-09324	Double edge 'Y' blade Suits TLX model		16.5MM A= 117 B= 48	40MM	8MM	100MM
BS-08490	Double edge blade 'Y' blade		25.5MM A= 147 B= 62	60MM	8MM	118MM
BS-08491	Flat double edge blade					

SICMA - CONTINUED



BoronBlue™



Part Number	Description	Diagram	HOLE	WIDTH	THICK	LENGTH from centre of hole
BS-08814	Double edge 'Y' blade Suits TS, TSL & TVF		20.5MM	40MM	10MM	97MM
			A= 110 B= 46			
CI-11/20	Cast hammer flail EM31					
			A= 150 B= 60 R= 90 20.5mm Hole			

SIMATECH

Part Number	Description	Diagram	HOLE	WIDTH	THICK	LENGTH from centre of hole
CI-09293	Cast hammer flail EM08/20 (with 20.5mm hole) DHL Range DHL80 & 95					
			A= 120 B= 40 R= 90 20.5mm Hole			

SOVEMA

Part Number	Description	Diagram	HOLE	WIDTH	THICK	LENGTH from centre of hole
BS-06943	Double edge 'Y' blade		25.4MM	60MM	10MM	171MM
BS-06943HF	Hard Faced Alternative					
BS-279005	Double edge 'L' blade					
BS-279003	Double edge Flat blade					
CI-08817	Single edge flail BSA-08818 Shackle					
			A= 79 B= 70 14mm x 25mm hole 3mm thick steel			

TIERRE

Part Number	Description	Diagram	HOLE	WIDTH	THICK	LENGTH from centre of hole
BS-09021	Double edge 'Y' blade BSA-08880 Bush 25 OD, 16.5ID x 52mm Wide		25.4MM	60MM	7MM	
			A= 215 B= 50			
BS-09022	Double edge Flat blade		25.4MM	60MM	8MM	
			A= 210			

Part Number	Description	Diagram	
CI-08996	Cast hammer flail OEM 16022, 411-480-643 Warlord etc		A= 76 B= 22 R= 95 16.5mm Hole
CI-09249	Gamma Flail style hammer. Cast hammer flail OEM 411-160-105 Can use CI-09249K (flail, bolt, nut & bush) CIA-09275 Bolt & Nut CIA-09276 Bush (16OD x 10ID x 11mm)		A= 55 B= 11 R= 85 16.5mm Hole

TTQ

Part Number	Description	Diagram	HOLE	WIDTH	THICK	LENGTH from centre of hole
BS-06943	Double edge 'Y' blade BSA-06943B 16mm Spacer BSA-09269 11.5mm Spacer BSA-06944P Split Pin style Bolt		25.4MM	60MM	10MM	171MM
BS-06943HF Hard Faced Option						

ZANON & INO

Part Number	Description	Diagram	HOLE	WIDTH	THICK	LENGTH from centre of hole
BS-09059	Double edge 'Y' blade		20.5MM	40MM	8MM	105MM
CI-09062	Cast hammer flail 14.5mm HOLE 14.5mm Hole Suits Ino Mulcher EM37		A= 119 B= 52			
CI-09384	Cast hammer flail 16.5mm HOLE 16.5mm Hole Suits Ino Mulcher EM37		A= 85 B= 40 R= 100 14.5 or 16.5mm HOLE			
CI-1401	Cast hammer flail ASP401 EM08 (with 16.5mm hole) CIA-08028 Fastener kit		Please check hole size			
			A= 120 B= 40 R= 90 16.5mm Hole			

ZENIT & MULCH MASTER

Part Number	Description	Diagram	
CI-08999	Hammer Flail EM40 BSA-06944P Pin & Split Pin BSA-06944SP Split Pin only		A= 105 B= 54 R= 98 25.5mm Hole
CI-08999HF	Hard Faced Option		

FLAIL BLADES

Part No.	W(mm)	T(mm)	(centre)	(overall)	H(mm)	
	Width	Thickness	Length	Length	Hole	Page
BS-09100	40	6	90	100	12.5	43
BS-336003	40	5	115	134	14.5	42
BS-09290	50	10	103	123	16.5	38
BS-08304	45	8	120	136	16.5	43
BS-1781000	40	8	110	128	16.5	45
BS-09324	40	8	100	117	16.5	47
BS-09291	50	10	98		16.5	38
BS-Y90HF	65	10	145	170	20	42
BS-08001	50	10	120	138	20.5	36
BS-08291	50	10	165	185	20.5	37
BS-08471 "L"	50	10	120	138	20.5	36
BS-09059	40	8	100	119	20.5	49
BS-08814	40	10	97	110	20.5	48
BS-09143HF	60	8	150	173	24	41
BS-06943	60	10	171	204	25.4	36
BS-08719	65	10	140	173	25.4	38
BS-09021	60	7	195	215	25.4	48
BS-09022	60	8	190	210	25.4	48
BS-09039	60	10	125	153	25.4	41
BS-279003 FLAT	60	10	171	204	25.4	45
BS-279005 "L"	60	10	171	204	25.4	45
BS-09390	60	7	218	245	25.4	42
BS-08303	60	8	190	210	25.5	43
BS-08490	60	8	115	150	25.5	47
BS-08491 FLAT	60	8	115	150	25.5	47
BS-08835	60	10	171	204	28.5	37
BS-09028HF	60	6	180	210	29	46
BM-100759HD	45	5	65	82	13 x 27	44
BM-181024	40	12	70	98	16 x 36	41



Y FLAILS



L FLAILS



FLAT FLAIL

HAMMERS

Part No.	R (mm)	A (mm)	H (mm)	B (mm)		Part No.	R (mm)	A (mm)	H (mm)	B (mm)	
	Radius	Cutting	Hole	Knuckle	Page		Radius	Cutting	Hole	Knuckle	Page
CI-09062	100	85	14.5	40	49	CI-11/20	90	150	20.5	60	48
CI-06/16	95	137	16.5	40	44	CI-09293	90	120	20.5	40	48
CI-08753	97	147	16.5	54	46	CI-09396	110	120	20.5	40	47
CI-08996	95	76	16.5	22	49	CI-09206	100	146	20.5	54	46
CI-1400	110	120	16.5	40	47	CI-09404	95	137	20.5	39	39
CI-1401	90	120	16.5	40	47	CI-08926	175	88	25.4	51	45
CI-09249	85	55	16.5	11	49	CI-08942	171	115	25.4	50	45
CI-09417	75	78	16.5	13	44	CI-08773	105	60	25.4	38	38
CI-09384	100	87	16.5	40	41	CI-1387	135	60	25.4	38	43
CI-09403	95	97	16.5	39	39	CI-08999	98	105	25.5	54	49
CI-08682	95	137	18.5	40	44	CI-09208	70	65	25.5	58	46
CI-09279	110	120	19.5	40	45	CI-FMB14	80	70	31	60	47
CI-08853	105	140	20	84	37	CI-08496	80	71	31	80	37
CI-08909	98	140	20	52	37	CI-08817	70	70	14 X 25	6	48
						CI-FMB003	85L, 68H	40W	16 x 32	11	37





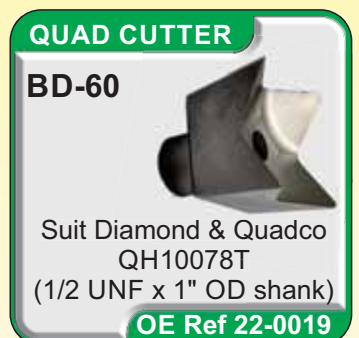





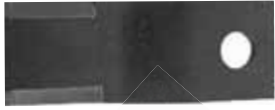











QUALITY STUMP GRINDER & FIXED MULCHER TEETH, AT AFFORDABLE PRICES!









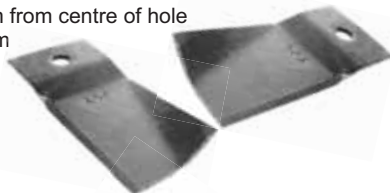

SWING TIP MOWER BLADES

(Blades to suit Push Mowers & Finishing Mowers)

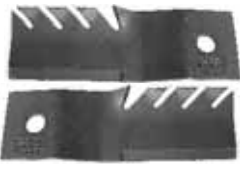
Part Number	Description	
AGRIFARM BS-30151 Replaces OEM 30151	Stepped, double edge swing tip blade Use with BSA-30444 Bolt set (includes 1 x bolt, nut & washer)	Length 110mm from centre of hole Hole 18mm Width 50mm Thick 5mm Step 10mm 
BUSHRANGER BD-08003 or BD-08279	Stepped & fluted swing tip blade - sold as a pair Right hand cut. Check length. BD-08003 Blades (124mm from centre of hole) BD-08563 Bolt Kit BD-08279 Blades (152mm from centre of hole) BD-08563 Bolt Kit	Hole 16mm Thick 2mm Step 5mm   NEW
COX BD-08012K Replaces OEM MB150AHD	Stepped & fluted swing tip blade & bolt set - sold as a pair, Right hand cut. Suit 28" & 48" Orion, Scout & Stockman (Includes 2 x blades & 2 x bolt, nut & washer)	Length 150mm from centre of hole Hole 13mm Width 50mm Thick 3mm Step 10mm 
GREENFIELD BD-08322K Replaces OEM	Greenfield Anniversary 28", 30" and 32" cut 8HP, 11HP and 12HP Models. Also Fits Evolution 1, 23 & 200, 30", 32" and 34" cut models Also Fits Tractor 11.30 MKII 30" Cut Models (Includes 2 x blades & 2 x bolt, nut & washer)	Length 185mm from centre of hole Hole 15mm Width 60mm 
HONDA BD-08003 BD-08003-10 (10 pair pack)	Stepped & fluted swing tip blade - sold as a pair Right hand cut. Suit 196, 197 & 215 BD-08003-10 10 Pairs of blades BD-08003BK Bolt set (sold as a pair with D washer) BD-08563 Bolt set (sold as a pair without D washer) BD-08206 Wave washer (sold each)	Length 124mm from centre of hole Hole 16mm Width 44mm Thick 2mm Step 5mm 
BD-08279 BD-08279-10 (10 pair pack)	Stepped & fluted swing tip blade - sold as a pair Right hand cut. HIGH LIFT Suit 216 & 217 BD-08279-10 10 Pairs of blades BD-08003BK Bolt set (sold as a pair with D washer) BD-08563 Bolt set (sold as a pair without D washer) BD-08206 Wave washer (sold each)	Length 152mm from centre of hole Hole 16mm Width 50mm Thick 2mm Step 5mm 
BD-08280	Stepped & fluted swing tip blade - sold as a pair Right hand cut. LOW LIFT Suit 216 & 217 BD-08003BK Bolt set (sold as a pair with D washer) BD-08563 Bolt set (sold as a pair without D washer) BD-08206 Wave washer (sold each)	Length 152mm from centre of hole Hole 16mm Width 50mm Thick 2mm Step 5mm 
BD-08003BK BD-08563	BD-08003BK Bolt set WITH D washers (sold as a pair) BD-08563 Bolt set without D washer (sold as a pair) BD-08563-10 10 pair pack	
AF-1332 OEM Ref: 17210-ZIV-003	Replacement air filter to fit GXV160H2 engines as fitted to HRU196, HRU216 etc - Complete with rubber seal on base and foam outer filter. Dimensions: 7 1/2" x 2-1/2" wide x 2" high	

Part Number	Description	
HONDA CONT ASP-701 OEM Ref: 42710-VA3-K00	Standard plastic wheel / rubber tread 7 3/4" diameter to suit 1/2" axle. Complete with cap.	
ASP-702 OEM Ref: 42810-VJ9-000	Self propelled rear drive plastic wheel / rubber tread. 7 3/4" diameter. Complete with cap.	
ASP-801 OEM Ref: 44710-VK0-C80 44710-VL9-B40	New type Honda front & rear wheel 8" with bearing suit 1/2" axle. suits HRU 196 /197K1 & M1 2010 onwards front & rear & front wheels on the 216k2 , M1 & M2 2010 onwards. Check OEM part number Tri Spoke style	
ASP-802 OEM Ref: 42810-VJ9-B80	Self propelled rear drive plastic wheel suit new style HRU216 Tri Spoke style	
HOWARD BR-78241 Replaces OEM 78241	Stepped & fluted swing tip blade - sold as each Left hand cut. Suit Series 1 Stealth, Procut & Rolla BMA-08065 Bolt set (sold each) BR-78241K Blade kit (includes 12 blades & fasteners)	Length 102mm from centre of hole Hole 13mm Width 50mm Thick 3mm Step 8mm 
BR-08754 (10 pack Blades) BRA-08755 (10 pack Bolts) OEM Ref: TX16084UK10, TX32205K10	ALTERNATIVE for OEM Trimax Lazer blades & bolts. (Will not suit the Condor). Stepped & fluted swing tip blade - sold as a KIT Left hand cut. Suit Series 2 Stealth, Procut & Pegasus. (Blade Kit includes 10 blades) MUST USE BRA-08755 BOLT KIT (Bolt Kit includes 10 x bolts & lock nuts)	Length 100mm from centre of hole Hole 20.5mm Width 50mm Thick 4mm Step 8mm 
JARRETT BM-08921 Replaces OEM 43751	Stepped & fluted swing tip blade - sold each Left hand cut. BSA-43752 Bolt set (sold each) (Bolt set includes 1 x bolt, nut & washer)	Length 100mm from centre of hole Hole 20.5mm Width 50mm Thick 4mm Step 8mm 
K-LINE BS-08905 LH BS-08906 RH	Stepped & fluted swing tip blade - sold each BS-08905 Left Hand Blade BS-08906 Right Hand Blade BSA-43752 Bolt set (sold each)	Length 135mm from centre of hole Hole 20.5mm Width 65mm Thick 4mm Step 20mm 
MASSPORT BD-09156K Oem part no. 529594 , 6352 007 1000, 780658	18" deck blade and bolt kit for masport & morrison mowers: Right Hand cut fits cushion, quickcut & quadcut blade systems, rear catcher. Pair Blades & Fasteners	Length 97mm from centre of hole Hole 13mm Width 44mm 
ROVER BD-08005K Replaces OEM 1118	Flat & fluted swing tip blade kit Right hand cut. Suits 18" rear catcher. Sold as a pair (2 blades, bolts, washers & nuts)	Length 94mm from centre of hole Hole 13mm Width 38mm 

Part Number	Description	
<p>SALIBA BS-08579 L/H BS-08580 R/H</p>	<p>Stepped & fluted swing tip blade - sold each BS-08579 Left hand cut. BS-08580 Right hand cut BSA-43752 Bolt set (sold each) BR-08423 Kit (includes 8x BS-08579, 8x BS-08580 & 16x BSA-43752)</p>	<p>Length 140mm from centre of hole Hole 20.5mm Width 65mm Thick 4mm Step 20mm</p> 
<p>SAMMUT BM-08577 L/H BM-08578 R/H</p>	<p>Stepped & fluted swing tip blade - sold each BM-08577 Left hand cut. BM-08578 Right Hand cut BSA-08036 Bolt set (sold each) BR-08422 Kit (includes 8x BM-08577, 8x BM-08578 & 16x BSA-08036)</p>	<p>Length 120mm from centre of hole Hole 18.5mm Width 65mm Thick 4mm Step 15mm</p> 
<p>SUPERIOR BR-03693 Replaces OEM S3693</p>	<p>Stepped & fluted swing tip blade - sold each Left hand cut. BRA-08088 Bolt set (sold each)</p>	<p>Length 197mm from centre of hole Hole 20mm Width 65mm Thick 5mm Step 18mm</p> 
<p>BR-08689</p>	<p>Stepped & fluted swing tip blade - sold each Right hand cut. BRA-08088 Bolt set (sold each)</p>	<p>Length 197mm from centre of hole Hole 20mm Width 65mm Thick 5mm Step 18mm</p> 
<p>BR-09218</p>	<p>Stepped swing tip blade - sold each Double Edge, Left & Right hand cut BRA-08088 Bolt set (sold each)</p>	<p>Length 197mm from centre of hole Hole 20mm Width 65mm Thick 5mm Step 18mm</p> 
<p>BR-08766 LH BR-09219 RH</p>	<p>Left hand cut - MULCH BRA-08088 Bolt set (sold each)</p> <p>Stepped & fluted swing tip blade - sold each Right hand cut - MULCH BRA-08088 Bolt set (sold each)</p>	<p>Length 197mm from centre of hole Hole 20mm Width 75mm Thick 5mm Step 18mm</p> 
<p>TORO BR-09297 Replaces OEM 116-6358-03</p>	<p>30" Deck TimeMaster 20199 , 20200 , 2014 30" cut TurfMaster Walk Behind Mowers Flat Mulch Blade RH cut Requires 2 per set</p>	<p>Length 389mm Centre Hole 16mm (2 x Outer Holes 7.5mm) Width 64mm Thick 4mm Step 11mm</p> 
<p>TRIMAX BR-08754 (10 pack Blades) BRA-08755 (10 pack) OEM Ref: 411-160-842, & 411-322-050</p>	<p>ALTERNATIVE for OEM Lazer blades & bolts. Stepped & fluted swing tip blade - sold as a KIT Left hand cut. Suit Series 2, 3 & 4 on Stealth, Procut, Pegasus, Merlin & Snake etc (BR-08754 Blade Kit includes 10 blades) MUST USE BRA-08755 BOLT KIT (BRA-08755 Bolt Kit includes 10 x bolts & lock nuts)</p>	<p>Length 100mm from centre of hole Hole 20.5mm Width 50mm Thick 4mm Step 8mm</p> 
<p>UNIVERSAL BM-V100RH & BM-V100LH</p>	<p>Stepped & fluted swing tip blade - sold each Right hand cut. BMA-08062 Bolt set (sold each) (Bolt set includes 1 x bolt, nut & washer) BM-V100RHK Bulk kit of 60 blades & fasteners BM-V100LH LEFT HAND - Sold as each blade</p>	<p>Length 120mm from centre of hole Hole 13mm Width 65mm Thick 3mm Step 6mm</p> 
<p>VICTA BD-08006K Replaces OEM Ca09306</p>	<p>Flat & fluted swing tip blades & bolts - sold as a pair of blades & bolts, washers & nuts Right hand cut. Suits 18" rear catcher.</p>	<p>Length 98mm from centre of hole Hole 15mm Width 44mm Thick 2mm Step N/A</p> 

TURF HARVESTER BLADES

6mm THICK SIDE PLATES WITH EXTRA DEPTH FOR LONGER CUTTING LIFE



PART NUMBER	SIZE	APPLICATION
BTC16-8	16 INCH	VAN VUUREN, BROUWER & POYNTZ
<i>BTC16-8-131</i>	16 INCH	AS ABOVE - WITH 4 X 131mm FINGERS
BTC16-8F	16 INCH	RYAN, KESMAC & SIMPSON
<i>BTC16-8F-131</i>	16 INCH	AS ABOVE - WITH 4 X 131mm FINGERS
<i>BTC16-8F-207</i>	16 INCH	AS ABOVE - WITH 4 X 207mm FINGERS
BTC18-8-1	18 INCH	VAN VUUREN, BROUWER & POYNTZ
<i>BTC18-8-1-131</i>	18 INCH	AS ABOVE - WITH 4 X 131mm FINGERS
BTC18-8F	18 INCH	RYAN, KESMAC & SIMPSON
<i>BTC18-8F-131</i>	18 INCH	AS ABOVE - WITH 4 X 131mm FINGERS
BTC23-8F	23 INCH	RYAN, KESMAC, BROUWER, TREBRO & FIREFLY ETC
<i>BTC23-8F-131</i>	23 INCH	AS ABOVE - WITH 5 X 131mm FINGERS
<i>BTC23-8F-180</i>	23 INCH	AS ABOVE - WITH 5 X 180mm FINGERS
<i>BTC23-8F-280</i>	23 INCH	AS ABOVE - WITH 5 X 280mm FINGERS
<i>BTC23-8F-300</i>	23 INCH	AS ABOVE - WITH 5 X 300mm FINGERS
BTC24-8F	24 INCH	RYAN, KESMAC, BROUWER, TREBRO & FIREFLY ETC
<i>BTC24-8F-180</i>	24 INCH	AS ABOVE - WITH 5 X 180mm FINGERS
<i>BTC24-8F-207</i>	24 INCH	AS ABOVE - WITH 5 X 207mm FINGERS
<i>BTC24-8F-230</i>	24 INCH	AS ABOVE - WITH 5 X 230mm FINGERS

ASP Turf cutters are the only blades available in Australia made entirely from European Boron steel. Both side plates and bottom blades are through hardened for maximum hardness and operational life. Our blades are used by Original Equipment Sod Harvester manufacturers in Europe.

The blade cutting edge is sharpened with a double bevel to ensure the cutting edge is maintained even in difficult stony areas.

BORON STEEL TURF CUTTERS

RIDE ON MOWER BLADES

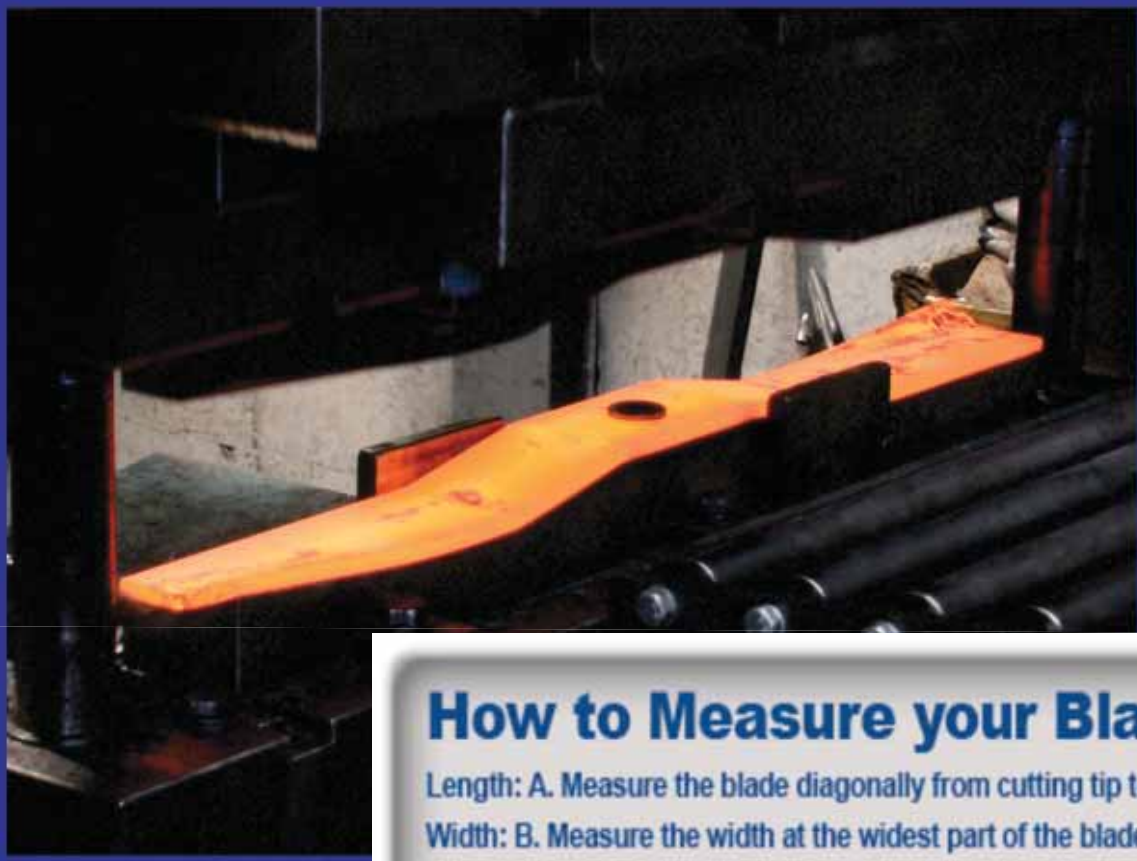

How to Measure your Blade

Length: A. Measure the blade diagonally from cutting tip to cutting tip.

Width: B. Measure the width at the widest part of the blade.

C. Measure the center hole.



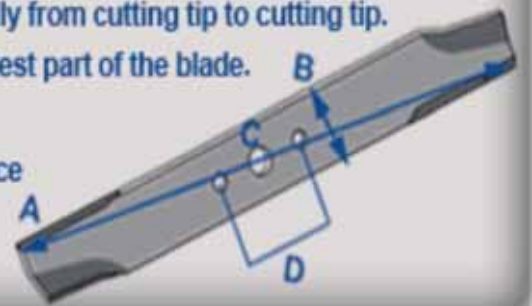



D. Measure the center to center distance between the outer holes.



ASP ride on mower blades are manufactured in Europe from high quality Boron steel to ensure wear capabilities that at the very least meet OEM standards but generally far exceed them.

ASP mower blades are typically 50Rc hardness, high carbon alternatives are typically 40Rc. The extra hardness in ASP blades means superior wear resistance and because Boron in the steel prevents the blade becoming brittle in heat treatment, it ensures you enjoy longer life from ASP blades.

ASP blades are without a doubt the best performing blade available for all Australian conditions.

<h1>ARIENS</h1>												
Part Number	Description											
BR-09304 Replaces OEM 00273000, 04919100	48" Deck - 3 Blade Deck (GATOR G6 396-716) Flat & Fluted Mulch Blade RH cut. Select models inc 715052, 715053, 715054, 715055, 788034, 788035, 788057, 788058, 792022, 792034, 888308, 915035 (1640), 915037 (1844), 915039 (2048), 915041 (2252), 915051 (1640), 988320 (HE1748FLPCE) <i>(Genuine Oregon G6 Gator, not ASP Boron)</i>	<table border="0"> <tr><td>Length</td><td>413mm</td></tr> <tr><td>Hole</td><td>16mm</td></tr> <tr><td>Width</td><td>75mm</td></tr> <tr><td>Thick</td><td>6mm</td></tr> <tr><td>Step</td><td>N/A</td></tr> </table> 	Length	413mm	Hole	16mm	Width	75mm	Thick	6mm	Step	N/A
Length	413mm											
Hole	16mm											
Width	75mm											
Thick	6mm											
Step	N/A											
<h1>BAD BOY</h1>												
Part Number	Description											
BR-08207 Replaces OEM 038-7220-00 038-7230-00	72" Deck - 3 Blade Deck Flat & Fluted Blade RH cut. Select models inc Outlaw & Lightning 7200, Z series & ZTR <i>(Note these are H/Duty 8mm thick blades not 1/4" like the OEM)</i>	<table border="0"> <tr><td>Length</td><td>621mm</td></tr> <tr><td>Hole</td><td>16mm</td></tr> <tr><td>Width</td><td>65mm</td></tr> <tr><td>Thick</td><td>8mm</td></tr> <tr><td>Step</td><td>N/A</td></tr> </table> 	Length	621mm	Hole	16mm	Width	65mm	Thick	8mm	Step	N/A
Length	621mm											
Hole	16mm											
Width	65mm											
Thick	8mm											
Step	N/A											
BR-08726 Replaces OEM 038-7220-00 038-7230-00	72" Deck - 3 Blade Deck Stepped & Fluted Mulch Blade RH cut. Select models inc Outlaw & Lightning 7200, Z series & ZTR	<table border="0"> <tr><td>Length</td><td>621mm</td></tr> <tr><td>Hole</td><td>16mm</td></tr> <tr><td>Width</td><td>65mm</td></tr> <tr><td>Thick</td><td>7mm</td></tr> <tr><td>Step</td><td>5mm</td></tr> </table>  <p style="text-align: right;">BoronBlue™ Mulcher Blades</p>	Length	621mm	Hole	16mm	Width	65mm	Thick	7mm	Step	5mm
Length	621mm											
Hole	16mm											
Width	65mm											
Thick	7mm											
Step	5mm											
BR-D18037 Replaces OEM 038-3000-00	36" Deck - 2 Blade Deck 52" Deck - 3 Blade Deck Flat & Fluted RH cut. Select models. Check sizes.	<table border="0"> <tr><td>Length</td><td>457mm</td></tr> <tr><td>Hole</td><td>16mm</td></tr> <tr><td>Width</td><td>65mm</td></tr> <tr><td>Thick</td><td>5mm</td></tr> <tr><td>Step</td><td>N/A</td></tr> </table> 	Length	457mm	Hole	16mm	Width	65mm	Thick	5mm	Step	N/A
Length	457mm											
Hole	16mm											
Width	65mm											
Thick	5mm											
Step	N/A											
BR-08891 Replaces OEM 038-3000-00	36" Deck - 2 Blade Deck 52" Deck - 3 Blade Deck Flat & Fluted MULCH blade RH cut. Select models. Check sizes.	<table border="0"> <tr><td>Length</td><td>457mm</td></tr> <tr><td>Hole</td><td>16mm</td></tr> <tr><td>Width</td><td>65mm</td></tr> <tr><td>Thick</td><td>6mm</td></tr> <tr><td>Step</td><td>N/A</td></tr> </table> 	Length	457mm	Hole	16mm	Width	65mm	Thick	6mm	Step	N/A
Length	457mm											
Hole	16mm											
Width	65mm											
Thick	6mm											
Step	N/A											



**Don't forget your
Trimmer Line!**

See page 86 for
details

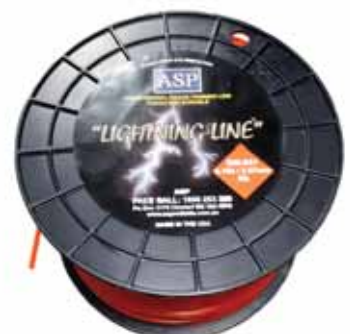

<h1>BIG DOG</h1>			
Part Number	Description		
BR-08952 Replaces OEM 600901, 793794,793794X	60" Deck R series (26HP model 931535) & ZTR Series Flat & Fluted. RH cut. Requires 3 blades per set	Length 520mm Hole 16mm Width 65mm Thick 6mm Step N/A	
BR-08910 Replaces OEM 794214, 794230	60" Deck R series (26HP model 931535) & ZTR Series Flat, Mulch. RH cut. Requires 3 blades per set	Length 520mm Hole 16mm Width 65mm Thick 6mm Step N/A	
BR-08950 Replaces OEM 601124	54" Deck R series 24HP model 931519 ZTR Flat & Fluted RH cut Requires 3 blades per set	Length 470mm Hole 16mm Width 65mm Thick 6mm Step N/A	
BR-09131 Replaces OEM	54" Deck R series 24HP model 931519 ZTR Flat & Mulch RH cut Requires 3 blades per set	Length 470mm Hole 16mm Width 65mm Thick 6mm Step N/A	
BR-08407 Replaces OEM 601123	48" Deck. R series 22 HP models 931493 & ZTR select models Flat & High Lift Flute. Right Hand cut. Requires 3 blades per set	Length 418mm Hole 16mm Width 65mm Thick 6mm Step N/A	
BR-08895 Replaces OEM 601123	48" Deck. R series 22 HP models 931493 & ZTR select models Flat & Mulch. Right Hand cut. Requires 3 blades per set	Length 418mm Hole 16mm Width 65mm Thick 6mm Step N/A	
<h1>BOB-CAT</h1>			
Part Number	Description		
BR-D18036 Replaces OEM 112111-03 112243-03 42180B	61" Deck. CRZ 61, FastCat Pro, Predator Pro, Procat SE, XRZ & ZTR Stepped & Fluted RH cut Requires 3 blades per set	Length 533mm Hole 16mm Width 65mm Thick 6mm Step 6mm	
BR-09304 Replaces OEM 112111-01	48" Deck - 3 Blade Deck - GATOR G6 396-716 Flat & Fluted Mulch Blade RH cut. Also 32" . Select models: CRZ48 (942600, 942600AU, XRZ48 (942610), FastCat Pro SE (942298H with serial # 2274 and below, ZTR models <i>(Blade is OEM Oregon Gator, not ASP Boron)</i>	Length 413mm Hole 16mm Width 75mm Thick 6mm Step N/A	

BOB-CAT Continued

<p>BR-D18036 Replaces OEM 112111-03, 112243-03</p>	<p>42" Deck, Stepped & Fluted RH cut Requires 2 blades per set Select models inc CRZ42 (942603, 942603EU, FastCat RZ 42 Select models & ZTR models Check dimensions.</p>	<p>Length 533mm Hole 16mm Width 65mm Thick 6mm Step 6mm</p> 
<p>BR-08891 Replaces OEM 32022, 32022a</p>	<p>36" Deck - 2 Blade Deck Flat & Fluted MULCH blade RH cut. Select models. Check sizes.</p>	<p>Length 457mm Hole 16mm Width 65mm Thick 6mm Step N/A</p> 
<p>BR-09304 Replaces OEM 112111-01</p>	<p>32" Deck - 2 Blade Deck - GATOR G6 396-716 Flat & Fluted Mulch Blade RH cut. <i>(Blade is OEM Oregon Gator, not ASP Boron)</i></p>	<p>Length 413mm Hole 16mm Width 75mm Thick 6mm Step N/A</p> 
<h2>CRAFTSMAN</h2>		
<p>Part Number</p>	<p>Description</p>	
<p>BR-08224 Replaces OEM 134149, 138971</p>	<p>42" Deck. Flat & Fluted. Right Hand cut. Requires 2 blades per set</p>	<p>Length 535mm Hole 5PT Star Width 57mm Thick 4mm Step N/A</p> 
<h2>CUB CADET</h2>		
<p>BR-08963 Replaces OEM 742-04053, 742-04123</p>	<p>50" Deck. Stepped & Fluted. Right Hand cut. Requires 3 blades per set RZT models etc <i>(Replaces the OEM 6 point star hole)</i></p>	<p>Length 452mm Hole 6PT Star Width 65mm Thick 5mm Step 24mm</p> 
<p>BR-09313 Replaces OEM 742-04417, X & 942-04417, 02005017-X, 1005336P, 2005017</p>	<p>48" Deck. Stepped Blade. G6 Gator 392-139. Right Hand cut. Requires 3 blades per set 17ASDALB099 (Z8200), 17BSDALB099 (Z8200) PRO Z100 <i>(Blade is Oregon Gator, not ASP Boron)</i></p>	<p>Length 432mm Hole 19mm Width 75mm Thick 6mm Step 11mm</p> 
<p>BR-115227A Replaces OEM 942-0616, 742-0616</p>	<p>42" Deck. Flat & Fluted. Mulch & Discharge Right Hand cut. Requires 2 blades per set ZTR & RZT42 <i>(Replaces the OEM 6 point star hole)</i></p>	<p>Length 539mm Hole 6PT Star Width 70mm Thick 4mm Step N/A</p> 

Part Number	Description	 
BR-09300 Replaces OEM 13926, 510417901, 532134149, 532138971, 539118038, 539119843, 539119852	61" Deck. Flat Blade. G5 Gator 596-900. Right Hand cut. Requires 3 blades per set To suit Selected models. Refer OEM Reference. <i>(Blade is Oregon Gator, not ASP Boron)</i>	Length 533mm Hole 5PT Star Width 75mm Thick 4mm Step N/A 
BR-08210 Replaces OEM 18931, 9383, 12441	Fits Toro 60" Deck Flat & Fluted R/H cut Requires 3 per set. Suits 8025, ZTR560 (1993), ZTR5601 (94-96), ZTR6601 (95-96) ZTR models	Length 520mm Hole 16mm Width 63mm Thick 6mm Step N/A 
BR-08910 Replaces OEM 18931, 9383, 12441	Fits Toro 60" Deck Flat & Fluted R/H cut Requires 3 per set. Suits 8025, ZTR560 (1993), ZTR5601 (94-96), ZTR6601 (95-96) ZTR models	Length 520mm Hole 16mm Width 64mm Thick 6mm Step N/A 
BR-09303 Replaces OEM 13867, 13918, 13943, 13944, 13945, 13947, 17279, 17280, 17281, 539119836, 539119862	44" Deck. Flat Blade. G3 Gator 496-399. Right Hand cut. Requires 3 blades per set To suit RAM & Selected models. Refer OEM Reference. <i>(Blade is Oregon Gator, not ASP Boron)</i>	Length 379mm Hole 17.5mm Width 63mm Thick 5mm Step N/A 
BR-08956 Replaces OEM 575296401	48" Deck - RAM ZTR Flat & Fluted RH cut. Requires 3 blades	Length 412mm Hole 5PT Star Width 65mm Thick 5mm Step N/A 
BR-08224 Replaces OEM 532134149	42" Deck - SPD ZTR Flat & Fluted RH cut. Requires 2 blades	Length 535mm Hole 5PT Star Width 57mm Thick 5mm Step N/A 
BR-08957 Replaces OEM 539112078	42" Deck - 3 Blade Deck Flat & Fluted RH cut. Requires 3 blades	Length 372mm Hole 5PT Star Width 65mm Thick 5mm Step N/A 

ELECTRIC MOWERS - TALK TO US ABOUT YOUR BLADE REQUIREMENTS

Need Trimmer Heads?
 ASP stocks Speed Feed style &
 Commercial Grade
 Italian 'F One' Rapid Feed heads.
 Refer page 87 for details.



FERRIS



Part Number	Description	
BR-08207 Replaces OEM 22476	72" Deck. Flat & Fluted. Right Hand cut. Requires 3 blades Selected ZTR models - <i>(Check blade length)</i> <i>(Note these are H/Duty 8mm thick blades not 1/4" like the OEM)</i>	Length 621mm Hole 16mm Width 65mm Thick 8mm Step N/A 
BR-08217 Replaces OEM 155000	72" Deck. Stepped & Fluted. Right Hand cut. Requires 3 blades <i>(Check blade length)</i>	Length 633mm Hole 16mm Width 65mm Thick 6mm Step 6mm 
BR-D18036 Replaces OEM 1520842, A48384, 502842, 5101755	61" Deck. Stepped & Fluted. Right Hand cut. Is32002, IS2000Z, IS2100Z, IS2500Z etc Requires 3 blades per set	Length 533mm Hole 16mm Width 65mm Thick 6mm Step 6mm 
BR-D18037 Replaces OEM 15212275, 1521227, A48185, 51017565, 1756152	52" (3 blades) & 36" (2 blades) Deck. Flat & Fluted. 5652852, Is2100, Is2500, F125, F150, 500S Right Hand cut.	Length 457mm Hole 16mm Width 65mm Thick 5mm Step N/A 
BR-08891 Replaces OEM 15212275, 1521227, A48185	52" (3 blades) & 36" (2 blades) Deck. Flat Mulcher. Right Hand cut.	Length 457mm Hole 16mm Width 65mm Thick 6mm Step N/A  <p style="text-align: right;">BoronBlue™ Mulcher Blades</p>
BR-09304 Replaces OEM 20843, 5020843, 5101986, 5103303	48" Deck - 3 Blade Deck (GATOR G6 396-716) Flat & Fluted Mulch Blade RH cut. Select models, F50XT, IS1500ZKAV21 & ZTR <i>(Genuine Oregon G6 Gator, not ASP Boron)</i>	Length 413mm Hole 16mm Width 75mm Thick 6mm Step N/A 
BR-08407	48" Deck. Flat & High Lift Flute. Right Hand cut. (some models only - check length) Requires 3 blades per set (Note: will not suit 400S models as they require 20mm hole)	Length 418mm Hole 16mm Width 65mm Thick 6mm Step N/A 
BR-08895	48" Deck. Flat Mulcher. Right Hand cut. (some models only - check length) Requires 3 blades per set	Length 418mm Hole 16mm Width 65mm Thick 6mm Step N/A  <p style="text-align: right;">BoronBlue™ Mulcher Blades</p>

Part Number	Description	Image
<h1>GRASSHOPPER</h1>		
BR-06271	72" Deck Stepped & Fluted RH cut Requires 3 blades per set Replaces OEM 320250	 <p>Length 639mm Hole 13mm Width 65mm Thick 6mm Step 7mm</p>
<h1>GRAVELY</h1>		
BR-08207 Replaces OEM 047685, 08983851	72" Deck Hi-Flow Blade Flat. RH cut. Requires 3 blades per set <i>(Note these are H/Duty 8mm thick blades not 1/4" like the OEM)</i>	 <p>Length 621mm Hole 16mm Width 65mm Thick 8mm Step N/A</p>
BR-08726 Replaces OEM 047685, 08983851, 09838	72" Deck Mulcher Blade. Stepped. RH cut. Requires 3 blades per set	 <p>Length 621mm Hole 16mm Width 65mm Thick 6mm Step 6mm</p>
BR-08952 Replaces OEM 046999, 08898900, 08979651	60" Deck 200-300 Series Flat & Fluted. RH cut. Requires 3 blades per set	 <p>Length 520mm Hole 16mm Width 65mm Thick 6mm Step N/A</p>
BR-08910 Replaces OEM 046999, 08898900, 08979651	60" Deck 200-300 Series etc Mulcher Blade Flat. RH cut. Requires 3 blades per set	 <p>Length 520mm Hole 16mm Width 65mm Thick 6mm Step N/A</p>
BR-D18037 Replaces OEM 450300, 4916400, 273100, 00273100	52" Deck Flat & Fluted RH cut Requires 3 blades per set 36" Deck Requires 2 blades	 <p>Length 457mm Hole 16mm Width 65mm Thick 5mm Step N/A</p>
BR-08891 Replaces OEM	52" Deck Mulcher Blade Flat. RH cut. Requires 3 blades per set 36" Deck Requires 2 blades	 <p>Length 457mm Hole 16mm Width 65mm Thick 6mm Step N/A</p>

GREAT DANE





Part Number	Description	
BR-D18036 Replaces OEM GDU10232, D18036	61" Deck Stepped & Fluted RH cut Requires 3 blades per set <i>Use blade Bolt BRA-08246</i>	Length 533mm Hole 16mm Width 65mm Thick 6mm Step 6mm 
BR-D18037 Replaces OEM GDU10231, D18037	52" and 36" Deck Flat & Fluted RH cut Requires 3 blades per set for 52" and 2 blades per set for 36".	Length 457mm Hole 16mm Width 65mm Thick 5mm Step N/A 
BR-08891 Replaces OEM GDU10231, D18037	52" and 36" Deck Mulcher Blade RH cut Requires 3 blades per set for 52" and 2 blades per set for 36". <i>Use blade Bolt BRA-08246</i>	Length 457mm Hole 16mm Width 64mm Thick 6mm Step N/A  BoronBlue™ Mulcher Blades
BR-08407 Replaces OEM GDU10230, D18086	48" and 32" Deck Flat & Fluted RH cut Requires 3 blades per set for 48" and 2 blades per set for 32". <i>Use blade Bolt BRA-08246</i>	Length 418mm Hole 16mm Width 64mm Thick 6mm Step 6mm 
BR-08895 Replaces OEM GDU10230, D18086	48" and 32" Deck Razorback Mulcher Blade RH cut Requires 3 blades per set for 48" and 2 blades per set for 32". <i>Use blade Bolt BRA-08246</i>	Length 418mm Hole 16mm Width 64mm Thick 6mm Step N/A  BoronBlue™ Mulcher Blades



HUSQVARNA









Part Number	Description	
BR-09300 Replaces OEM 138498, 138791, 138971, 510417901, 521981601, 531307224, 532131323, 53213897, 539113312	61" Deck. Flat Blade. G5 Gator 596-900. Right Hand cut. Requires 3 blades per set Ez6124, MZ61, MZ460X, Z560, MZ6128 577240401, 586230101, 917127843, 917131323, 917138489MS, 917532138498 <i>(Blade is Oregon Gator, not ASP Boron)</i>	Length 533mm Hole 5Pt Star Width 75mm Thick 4mm Step N/A 
BR-D18036 Replaces OEM 53910293, 539101733	61" Deck Stepped & Fluted RH cut ZTH6123KAA, WHF5218ETS Requires 3 blades per set	Length 533mm Hole 16mm Width 65mm Thick 6mm Step 6mm 
BR-D18037 Replaces OEM 5391057-12, 5391003-41, AYP100341	52" Deck & 36" Deck Flat & Fluted RH cut Requires 3 blades per set for 52" and 2 blades per set for 36"	Length 457mm Hole 16mm Width 65mm Thick 5mm Step N/A 

BR-08891 Replaces OEM 5391057-12, AYP100341	52" Deck & 36" Deck Mulcher Blade RH cut, Requires 3 blades per set for 52" and 2 blades per set for 36"	Length 457mm Hole 16mm Width 65mm Thick 6mm Step N/A	 BoronBlue™ Mulcher Blades
BR-09306 Replaces OEM 574870801, 575240701	52" Deck Flat Blade. G5 Gator 595-077. Right Hand cut. Requires 3 blades per set To suit Selected models. Refer OEM Reference. <i>(Blade is Oregon Gator, not ASP Boron)</i>	Length 451mm Hole 5PT Star Width 75mm Thick 4mm Step N/A	
BR-08956 Replaces OEM 539 11 34-25	48" Fabricated Decks YTH2648TDF, ZTR & Ez4824 MODELS, TS348 Flat & Fluted RH cut Requires 3 blades per set.	Length 413mm Hole 5PT Star Width 64mm Thick 5mm Step N/A	
BR-08407 Replaces OEM 539 10 60-40, AYP100340	48" Decks IZ4821 & ZTR models Flat & Fluted RH cut Requires 3 blades per set.	Length 418mm Hole 16mm Width 64mm Thick 6mm Step N/A	
BR-08895 Replaces OEM 539 10 60-40, AYP100340	48" Decks IZ4821 & ZTR models Flat Mulch RH cut Requires 3 blades per set.	Length 418mm Hole 16mm Width 64mm Thick 6mm Step N/A	 BoronBlue™ Mulcher Blades
BR-09319 Replaces OEM 173920, 180054, 917173920, 917532173920, 917532180054, 954633774	48" Decks Flat Blade. G3 Gator 96-615 Requires 3 blades per set. 512258301, 532173920, 532180054, 539107519, 575938201, 575938301, 577146201, YTH1848, YTH2148, YTH2548 etc <i>(Blade is Oregon Gator, not ASP Boron)</i>	Length 424mm Hole 5 PT Star Width 64mm Thick 5mm Step N/A	

OEM Reference numbers are used for identification only, we also encourage you to check blade dimensions prior to ordering. ASP blades are not sold as genuine.

BR-09301 Replaces OEM 532405380, 594892801	46" Deck. Step Blade Oregon 195-070. Right Hand cut. Requires 2 blades per set To suit Selected models. Refer OEM Reference. 405380, 532405380, 575937901, 777405380, 917532405380, 917777405380 <i>(Blade is Oregon, not ASP Boron)</i>	Length 581mm Hole 5PT Star Width 70mm Thick 4mm Step 8mm	
BR-09300 Replaces OEM 539113312	42" Deck. Flat Blade. G5 Gator 596-900. Right Hand cut. Requires 2 blades per set To suit Selected models. Refer OEM Reference. <i>(Blade is Oregon Gator, not ASP Boron)</i>	Length 533mm Hole 5PT Star Width 75mm Thick 4mm Step N/A	
BR-08224 Replaces OEM 532138498, AYP138498, 127843, 532138971 AYP138971	Fits Husqvarna 42" Decks Lt125, Lt140, Lt150, LTH1342, XTH1542XP Models, LTH1742, LTH1842 & LTH2142D etc YTH1542XP Flat & Fluted RH cut Requires 2 blades per set.	Length 535mm Hole 5PT Star Width 57mm Thick 4mm Step N/A	

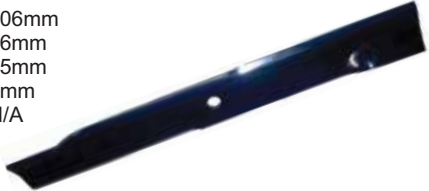
<p>BR-09305 Replaces OEM 539112078, 573953001, 577146101</p>	<p>42" Decks Flat Blade. G3 Gator 95-088 Requires 3 blades per set. Ez4216, Ez4217, Ez4220 & Fabricated decks Flat & Fluted RH cut <i>(Blade is Oregon Gator, not ASP Boron)</i></p>	<p>Length 371mm Hole 5PT Star Width 64mm Thick 5mm Step N/A</p> 
<p>BR-08957 Replaces OEM 5391120-78</p>	<p>Fits Husqvarna 42" Decks Ez4216, Ez4217, Ez4220 & Fabricated decks Flat & Fluted RH cut Requires 3 blades per set.</p>	<p>Length 371mm Hole 5PT Star Width 65mm Thick 5mm Step N/A</p> 
<p>BR-09318 Replaces OEM 513897001, 531307220, 531307221, 532127842, 532131322, 532134148</p>	<p>Fits 38" Deck Flat Blade. G3 Gator 95-601 Lt19538 etc 581116302, 777193957, 917127842, 917131322, 917134148MS, 917134148X, 917139774MS, 917532134148, 917532138497, 917532138970, 917532139774, 917532193957 <i>(Blade is Oregon Gator, not ASP Boron)</i></p>	<p>Length 489mm Hole 5PT Star Width 64mm Thick 5mm Step N/A</p> 
<h1>HUSTLER</h1>		
		
<p>BR-09243K 5 BLADE KIT</p>	<p>Fits SUPER 104. Blade Kit includes: 1 x BR-08954 RH cut wing blade 1 x BR-08955 LH cut wing blade 2 x BR-08952 RH centre deck blades 1 x BR-08953 LH centre deck blades</p>	
<p>BR-08207 Replaces OEM 798702, 9820361 <i>(Note these are H/Duty 8mm thick blades not 1/4" like the OEM)</i></p>	<p>Fits 72" Deck Flat & High Fluted RH cut, Side Discharge Xr7 series, Super Z HD & 3700 series Requires 3 blades per set <i>(will not suit old model Super Z - check length)</i> Use BRA-08948 Bolt & BRA-83665 Washer</p>	<p>Length 621mm Hole 16mm Width 65mm Thick 8mm Step N/A</p> 
<p>BR-08726 Replaces OEM 798702, 9820361</p>	<p>Fits 72" Deck Stepped Mulcher RH cut Xr7 series & 3700 series Requires 3 blades per set Use BRA-08948 Bolt & BRA-83665 Washer</p>	<p>Length 621mm Hole 16mm Width 65mm Thick 7mm Step 5mm</p>  <p style="text-align: right;">BoronBlue™ Mulcher Blades</p>
<p>BR-08954 Replaces OEM 796839, 794867, 784728</p>	<p>Fits REAR DISCHARGE 72" Deck Flat & Fluted RIGHT HAND cut <i>(Requires 2 x BR-08954 RIGHT HAND & 1x BR-08955 LEFT HAND)</i> <i>(also old model Super Z - check length)</i> Use BRA-08948 Bolt & BRA-83665 Washer</p>	<p>Length 606mm Hole 16mm Width 65mm Thick 6mm Step N/A</p> 
<p>BR-08955 Replaces OEM 796508, 601929</p>	<p>Fits REAR DISCHARGE 72" Deck Flat & Fluted LEFT HAND cut <i>(Requires 2 x BR-08954 RIGHT HAND & 1x BR-08955 LEFT HAND)</i> Use BRA-83665 Washer - Bolt not available</p>	<p>Length 606mm Hole 16mm Width 65mm Thick 6mm Step N/A</p> 

**ALL BLADES ARE SOLD AS SINGLES
(INDIVIDUALLY) UNLESS STATED. PLEASE ORDER
THE QUANTITY REQUIRED TO MAKE UP A SET.**

BR-08952 Replaces OEM 602771, 794685, 793794	Fits 60" Deck Side Discharge Flat & Fluted Blade RH cut Suits VX4, X-One, Fastrak, Sport etc Requires 3 blades per set Use BRA-08948 Bolt & BRA-83665 Washer	Length 520mm Hole 16mm Width 65mm Thick 6mm Step N/A	
BR-08910 Replaces OEM 794230, 794214	Fits 60" Deck Flat Mulcher Blade RH cut Suits VX4, X-One, Fastrak, Sport etc Requires 3 blades per set Use BRA-08948 Bolt & BRA-83665 Washer	Length 520mm Hole 16mm Width 64mm Thick 6mm Step N/A	
BR-08953 Replaces OEM 795633, 601928	Fits 60" REAR DISCHARGE Deck Flat & Fluted Blade LEFT HAND cut <i>Requires 2 x (BR-08952) RIGHT HAND & 1 x (BR-08953) LEFT HAND</i>	Length 520mm Hole 16mm Width 65mm Thick 6mm Step N/A	
BR-08950 Replaces OEM 797696, 797704, 601012	Fits 54" Deck Side Discharge Flat & Fluted RH cut Xr7 series, Fastrak, Sport, X-One VX4 etc Requires 3 blades per set	Length 470mm Hole 16mm Width 65mm Thick 6mm Step N/A	
BR-09131 Replaces OEM	Fits 54" Deck Side Discharge - MULCH Flat & Fluted RH cut Xr7 series, Fastrak, Sport, X-One VX4 etc Requires 3 blades per set	Length 470mm Hole 16mm Width 65mm Thick 6mm Step N/A	
BR-08951 Replaces OEM 601013	Fits 54" REAR DISCHARGE Deck Flat & Fluted Blade LEFT HAND cut Requires 2 x (BR-08950) RIGHT HAND & 1 x (BR-08951) LEFT HAND	Length 470mm Hole 16mm Width 65mm Thick 6mm Step N/A	
BR-D18037 Replaces OEM 783753, 785436	Fits 52" Deck Flat & Fluted RH cut Fastrak, Mini Z etc Requires 3 blades per set Also 36" Stand On - 2 blades	Length 457mm Hole 16mm Width 65mm Thick 5mm Step N/A	
BR-08891 Replaces OEM 783753, 785436	Fits 52" Deck Flat Mulcher RH cut Fastrak, Mini Z etc Requires 3 blades per set Also 36" Stand On - 2 blades	Length 457mm Hole 16mm Width 65mm Thick 6mm Step N/A	
BR-08407 Replaces OEM 601123, 797757	Fits 48" Deck Flat & High Fluted Blade RH cut Suits Vx4, X-One, Fastrak, Super Duty etc Requires 3 blades per set	Length 418mm Hole 16mm Width 64mm Thick 6mm Step N/A	
BR-08895 Replaces OEM 796623, 796631	Fits 48" Deck Flat Mulcher Blade RH cut Suits Vx4, X-One, Fastrak, Super Duty etc Requires 3 blades per set	Length 418mm Hole 16mm Width 64mm Thick 6mm Step N/A	

BR-09307 Replaces OEM 785728, 787739	Fits 44" Deck G3 Gator 96-302 Flat Mulcher Blade R/H cut Suits Various, check OEM Ref number Requires 3 blades <i>(Blade is Oregon Gator, not ASP Boron)</i>	Length 397mm Hole 16mm Width 70mm Thick 5mm Step N/A 
BR-08952 Replaces OEM	Fits 42" Deck Flat & Fluted Blade R/H cut Suits Fastrak, Raptor & Zeon series Requires 2 blades	Length 520mm Hole 16mm Width 65mm Thick 6mm Step N/A 
BR-08910 Replaces OEM	Fits 42" Deck Flat Mulcher Blade R/H cut Suits Fastrak, Raptor & Zeon series Requires 2 blades	Length 520mm Hole 16mm Width 65mm Thick 6mm Step N/A  BoronBlue™ Mulcher Blades
Part Number	ISEKI Description	
BR-07162A Replaces OEM 3496107M91, 3495550M4	Fits 72" Deck Stepped & Fluted RH cut Sf300 Series etc Requires 3 blades per set Use BRA-83665A washer & BRA-100293 Nut	Length 628mm Hole 20mm Width 60mm Thick 7mm Step 15mm 
BR-09389 Replaces OEM 3496107M91, 3495550M4	Fits 72" Deck Mulch Blade Stepped & Fluted RH cut Sf300 Series etc Requires 3 blades per set Use BRA-83665A washer & BRA-100293 Nut	Length 628mm Hole 20mm Width 60mm Thick 7mm Step 15mm NEW  BoronBlue™ Mulcher Blades
BR-0525A Replaces OEM 797696, 797704, 601012, 3496363M1	Fits 60" Deck Stepped & Fluted RH cut Sf300 Series etc Requires 3 blades per set Use BRA-83665A washer & BRA-100293 Nut	Length 527mm Hole 20mm Width 60mm Thick 7mm Step 15mm 
BB-08040 Replaces OEM 865520201301	BELT to suit 72" Deck Suits SF300 & Sf340 (Will not suit other models)	

**ALL BLADES ARE SOLD AS SINGLES (INDIVIDUALLY)
PLEASE ORDER THE QUANTITY REQUIRED TO MAKE
UP A SET.**



OEM Reference numbers are used for identification only, we also encourage you to check blade dimensions prior to ordering.

ASP blades are not sold as genuine.

JOHN DEERE



Part Number	Description	
BR-07473 Replaces OEM M119565, M80783, Am102401, M141786	Fits John Deere 72" Deck 1145 series, 850, 855, 870, 950, 970, 1050, 1070, 4115, 4200, 4210, 4300, 4400, 4500, 4600, 4610, 4700, 4710, F925, F930, F932, F935. Flat & Fluted Blade. Requires 3 per set Use Bolt BRA-100195, Washer BRA-83665.	Length 634mm Hole 23mm Width 65mm Thick 8mm Step N/A 
BR-07473S Replaces OEM M141669, M83363, EPC201693	Fits John Deere 72" Deck Standard Lift Blade 1445, 1545, 1565, 1585, 777, 797, 4200, 4500 series, 997 Diesel & 1580 Terrain, Side & Rear Discharge. Stepped and Fluted. Requires 3 per set. Use Bolt BRA-100195SH, Use Tension Washer BRA-83665.	Length 632mm Hole 23mm Width 60mm Thick 8mm Step 10mm 
BR-08772 Replaces OEM TCU15882, M141669, M143749	Fits John Deere 72" Deck 1435, 1565, 1585, Z830A, 997, 1445, Z950A, Z950M, Z950R, Z960M, Z970R, Z970A, Z960A Stepped, High Lift Blade Requires 3 Per Set. Bolt BRA-100195SH, Washer BRA-83665.	Length 632mm Hole 23mm Width 75mm Thick 7mm Step 12mm 
BR-08466 Replaces OEM M142514	Fits John Deere 72" Decks 1145 etc Stepped Mulcher Blade Requires 3 Per Set. Use Bolt BRA-100195SH, Use Tension Washer BRA-83665.	Length 634mm Hole 23mm Width 65mm Thick 8mm Step 7mm 
BR-09019 Replaces OEM M141786, M141669, M83363, EPC201693	Mulcher style to Fit 72" decks on 1445, 1545, 1565, 1585, 777, 797, 4200, 4500 series, 997 Diesel & Terrain. Side & Rear Discharge. Requires 3 per set. Step & Fluted. Use Bolt BRA-100195SH, Use Tension Washer BRA-83665.	Length 632mm Hole 23mm Width 65mm Thick 7mm Step 13mm  <p>BoronBlue™ Mulcher Blades</p>
BR-08560 Replaces OEM TCU51118, M144297	Fits 62" Deck, 7 Iron Deck & 1600 Wide area mower, 1400-1500 Series & Terrain. 1600 series 3 Turbo. Stepped and Fluted Blade. Use Bolt BRA-100195SH, Use Tension Washer BRA-83665.	Length 555mm Hole 23mm Width 65mm Thick 8mm Step 8mm 
BR-06253 Replaces OEM M141785, M87622	Fit's John Deere 60" Deck F1145 Flat & Fluted Blade Requires 3 blades per Set	Length 521mm Hole 23mm Width 65mm Thick 8mm Step N/A 
BR-128485 Replaces OEM TCU15881, M128485, M133381	Fits 60" Deck - Stepped & Fluted Z950A, M665, F620, F680, F687, 737, 757, 777, 797 Diesel, 1420, 1435, 1445, 1545, X700, 1565, 4210, 4310, 4410, Z830A, Z720A, Z960A, Z830, 840, 850, Z860, Z970R, Z997, Z994R, Z915E, Z920 - Z960M, 1026R, ZTRAC & Terrain - Requires 3 blades per set	Length 529mm Hole 23mm Width 65mm Thick 8mm Step 10mm  <p>Bolt BRA-100195SH, Washer BRA-83665.</p>
BR-128485M Replaces OEM TCU15881, M128485, M133381	Fits 60" Deck - MULCH Stepped & Fluted Z950A, M665, F620, F680, F687, 737, 757, 777, 797 Diesel, 1420, 1435, 1445, 1545, X700, 1565, 4210, 4310, 4410, Z830A, Z720A, Z960A, Z830, 840, 850, Z860, Z970R, Z997, Z994R, Z915E, Z920 - Z960M, ZTRAC & Terrain - Requires 3 blades per set	Length 529mm Hole 23mm Width 65mm Thick 8mm Step 10mm  <p>BoronBlue™ Mulcher Blades</p> <p>Bolt BRA-100195SH, Washer BRA-83665.</p>





BR-08470 Replaces OEM M136195, TCU30316, M144652, TCU30317 M164016	54" Deck Stepped & Fluted Blade X700, 737, Z820A, Z830A, Z920, Z710A, Z740R, Z915B, Z925, Z915E, Z920M, Z930M, Z930R, Z720E, X738, X758 Requires 3 Per Set. BRA-100195SH Bolt & BRA-83665 Washer	Length 483mm Hole 23mm Width 65mm Thick 5mm Step 7mm 
BR-09310 Replaces OEM M136195, TCU30316, M144652, TCU30317 M164016	54" Deck. G6 Gator 396-769 Stepped & Fluted Blade X700, 737, Z820A, Z830A, Z920, Z710A, Z740R, Z915B, Z925, X738, X758 Requires 3 Per Set. <i>(Blade is Oregon Gator, not ASP Boron)</i>	Length 483mm Hole 23mm Width 75mm Thick 6mm Step 10mm 
BR-08962 Replaces OEM M143520, M145516	54" Deck Z375, Z425, X320, X380, Z540, X748, 737, Z820A, EZ Trac, GX & X570, X580, X584, X590 Z & LX series 1025, Z445, X540, 1026R, Z515E. Stepped & Fluted Blade. Requires 3 Per Set.	Length 480mm Hole 20mm Width 65mm Thick 6mm Step 10mm 
BR-09309 Replaces OEM M143520, M145516, M152726, UC22010	54" Deck. G6 Gator 396-769 Z425, X320, X380, Z540, X748, 737, Z820A, EZ Trac, GX & X570, X580, X584, X590 Z & LX series 1025, Z445, X540 Requires 3 Per Set. Stepped & Fluted Blade <i>(Blade is Oregon Gator, not ASP Boron)</i>	Length 481mm Hole 20mm Width 75mm Thick 6mm Step 12mm 

**ALL BLADES ARE SOLD AS SINGLES (INDIVIDUALLY)
PLEASE ORDER THE QUANTITY REQUIRED TO MAKE
UP A SET.**

BR-127500 Replaces OEM M145476, M127500, Uc22009	48" & 48C & ACCEL Decks Lx277, LX279, LX280, LX289, GT245, GT235E, GX325, GX335, X355, X380, 465, 475, 485, 495, 575, LT180, X700, 700, 720, 724, 728, Z425, Z445, X324, X320, X590, Z515E Requires 3 blades per set	Length 433mm Hole 21mm Width 65mm Thick 5mm Step 7mm 
BR-08701 Replaces OEM, M136185, TCU21475, TCU14939, M136194, TCU30315	48" Deck F620, F680, Z510A, Z645, Z710A, Z810A, Z740, Z820A, Z910A, Z915E, Z920M, 17H17B & Zg18 Walk Behinds & Z720E Stepped Hi Lift Blade Right Hand cut. Requires 3 blades per set BRA-100195SH Bolt, BRA-83665 Washer	Length 430mm Hole 23mm Width 65mm Thick 6mm Step 17mm 
BR-09298 Am137757, AM137758, AM141035, AM141036, GX21784, GX21785, Gx21786, Gy20852	48" Deck. G3 Gator 92-616 Stepped & Fluted. Requires 3 blades per set. 145 155C LA130 LA140 LA145 LA155 LA165 Lawn Tractors, D140 D150 D155 D160 E140 E150 E160 E170 100 Series Tractors X140 X165 X166 Select Series Tractors Z245 Z255 Z355E Ztrak <i>(Blade is Oregon Gator, not ASP Boron)</i>	Length 432mm Hole 7 Pt Star Width 63mm Thick 5mm Step 6mm 
BR-08756 Replaces OEM Gx22151, Gy20850 Am137329, UC21583	42" Deck "Starlock blade" D110, Z225, LA100, LA105, LA110, LA115, LA120, LA125, LA135, X110, X120, X300, D110, D130, S240 Sport, E100, E120, E130, Z235 EZTRAK Mulch & Discharge Blade Right Hand cut Requires 2 blades per set.	Length 543mm Hole 7 Pt Star Width 65mm Thick 4.5mm Step N/A 
BR-20249 Replaces OEM Gx20249, GX20433	42" Deck Sabre, L100, L108, L110, L111, Mulch Blade Right Hand cut Flat & Fluted Requires 2 blades per set	Length 545mm (11mm outer holes @ 95mm) Hole 17mm Width 65mm Thick 5mm Step N/A 

Part Number

JOHN DEERE Continued

<p>BR-09183 Replaces OEM M170639</p>	<p>42" ACCEL Deck X300, X354, X370, Z335 & Z345 Mulch & Discharge Blade Right Hand cut Requires 2 blades per set.</p>	<p>Length 543mm Hole 20mm Width 65mm Thick 4.5mm Step N/A</p>	
<p>BR-330397 Replaces OEM M83459, AM100991</p>	<p>38" Deck High Lift Lt150, STX38, F525 Stepped & Fluted Blade Right Hand cut Requires 2 blades per set</p>	<p>Length 494mm Hole 18mm Width 75mm Thick 5mm Step 5mm</p>	
<p>BR-330290 Replaces OEM M82408, M84472, AM100946</p>	<p>38" Deck Low Lift LX170, LX180, LT150, LX255, LX288, LX176, LX172, LX188, X300 LX Stepped & Fluted Blade Right Hand cut Requires 2 blades per set.</p>	<p>Length 494mm Hole 18mm Width 65mm Thick 5mm Step 5mm</p>	
<p>BR-09308 Replaces OEM Am104652, M112974, M112991, M118958, M74449, M82408, M84472</p>	<p>38" Deck. G6 Gator 396-709 Stepped & Mulch Blade LX170, LX180, LT150, LX255, LX288, LX176, LX172, Lx188 Requires 2 Per Set. <i>(Blade is Oregon Gator, not ASP Boron)</i></p>	<p>Length 495mm Hole 18mm Width 75mm Thick 6mm Step 10mm</p>	
<p>BB-08040 Replaces OEM M112414, B144</p>	<p>72" John Deere Side Discharge Deck Belt F1145 Model (will not suit later models)</p>		

Don't forget your Trimmer Line, Edger Blades & Litter Tools!











Refer page 85 onwards for details.











KUBOTA



Part Number	Description	
BR-08826 Replaces OEM K5677-34340, 70000-25002, 76553-34330, 76550-34350	Fits Kubota 72" Deck , High Flow Deck, Stepped & High Fluted, Right hand cut RCK72-28Z(P), RCK72-27B, 30B, RC72-38, RC72-F30, RCK72P-331Z, RCK72P-F36, ZD28, ZD29, 2560, 3060, 3560, F3690, ZD331 Requires 3 blades per set	Length 622mm Hole 28.5mm Width 75mm Thick 7mm Step 15mm  Use BRA-K6845 Bolt & BRA-K6846 Washer & BRA-09411 Cup
BR-07462 Replaces OEM K5677-34340,70000-25002, 76553-34330, 76550-34350, 76539-34372, K5698-34340	Fits Kubota 72" Deck - Standard blade Stepped & Fluted, Right hand cut, RCK72RP-1200Z, RCK72-28Z(P), RCK72-27B, 30B, RC72-38, RC72-F30, RCK72P-331Z, RCK72P-F36, ZD28, ZD29, 2560, 3060, 3560, F3690, ZD331. Requires 3 blades per set	Length 622mm Hole 28.5mm Width 65mm Thick 7mm Step 14mm  Use BRA-K6845 Bolt & BRA-K6846 Washer & BRA-09411 Cup
BR-08703 Replaces OEM K5677-34340,70000-25002, 76553-34330, 76550-34350, 76539-34372, K5677-9234	Fits Kubota 72" Deck Stepped Mulching Blade for all models with 29mm Holes Stepped & Fluted Blade RH cut Requires 3 blades per set	Length 622mm Hole 28.5mm Width 65mm Thick 7mm Step 14mm  BoronBlue™ Mulcher Blades Use BRA-K6845 Bolt & BRA-K6846 Washer & BRA-09411 Cup
BR-07129 Replaces OEM 76550-34330	Fits Kubota 72" Deck Stepped & Fluted, Right hand cut RCK72-25, RC72-28, RC72-29, 29A, RC72-36, 36A, RC-72F20, F24, RC72R-F36B, F2400. Requires 3 blades per set.	Length 620mm Hole 23mm Width 60mm Thick 7mm Step 12mm  Use BRA-K6845 Bolt & BRA-K6846 Washer & BRA-09411 Cup
BR-09085 Replaces OEM K5975-34360	Fits Kubota 72" Deck ZD1200 series deck, ZD1221, RCK72P-1200Z Hi Lift blade Requires 3 blades per set	Length 622mm Hole 34mm Width 75mm Thick 7mm Step 15mm  Use BRA-K6845 Bolt & BRA-09118 Washer & BRA-09427 Cup
BR-09077 Replaces OEM K5975-34360	Fits Kubota 72" Deck ZD1200 series deck ZD1221, RCK72P-1200Z Standard blade Requires 3 blades per set	Length 622mm Hole 34mm Width 65mm Thick 7mm Step 14mm  Use BRA-K6845 Bolt & BRA-09118 Washer & BRA-09427 Cup
BR-09079 Replaces OEM	Fits Kubota 72" Deck ZD1200 series deck ZD1221, RCK72P-1200Z Mulch blade Requires 3 blades per set	Length 622mm Hole 34mm Width 65mm Thick 7mm Step 14mm  BoronBlue™ Mulcher Blades Use BRA-K6845 Bolt & BRA-09118 Washer & BRA-09427 Cup
BR-06677 Replaces OEM K5651-34340, 76539-34330, 70000-25001, K5647-34330, 76539-34372, 76550-34350, K5645-34340, K5651-34330	Fits Kubota 60" Decks ZD21, ZD28, ZD331, ZG & D 326 & 327, ZG331, ZG326P, RCK60-28Z, RCK60-29B, RCK60-30B, RCK60-F30, RCK60P-21Z, RCK60P-327Z, RCK60-F36, RC60-21B, RC60-24B, RC60-71B, RC60-F19, RC60-FZ21,F3690 RCK60-24B, RCK60-27B. Requires 3 Blades	Length 520mm Hole 28.5mm Width 65mm Thick 7mm Step 14mm  Use BRA-K6845 Bolt & BRA-K6846 Washer & BRA-09411 Cup
BR-09020 Replaces OEM K5651-34340, 76539-34330, 70000-25001, K5647-34330, 76539-34372, 76550-34350	Mulch blade alternative to BR-06677 60" Decks ZD21, ZD28, ZD331, ZG/ZD326 & 327, ZG331, ZG326P, RCK60-28Z, RCK60-29B, RCK60-30B, RCK60-F30, RCK60P-21Z, RCK60P-327Z, RCK60-F36, RC60-21B, RC60-24B, RC60-71B, RC60-F19, RC60-FZ21,F3690 RCK60-24B Requires 3 Blades	Length 520mm Hole 28.5mm Width 65mm Thick 7mm Step 14mm  BoronBlue™ Mulcher Blades Use BRA-K6845 Bolt & BRA-K6846 Washer & BRA-09411 Cup

<p>BR-09386 Replaces OEM K5651-34340, 76539-34330 70000-25001, K5647-34330 76539-34372, 76550-34350, K5645-34340, K5651-34330</p>	<p>Fits Kubota 60" Decks HIGH LIFT ZD21, ZD28, ZD331, Zg326 & 327, ZG331, ZG326P, RCK60-28Z, RCK60-29B, RCK60-30B, RCK60-F30, RCK60P-21Z, RCK60P-327Z, RCK60-F36, RC60-21B, RC60-24B, RC60-71B, RC60-F19, RC60-FZ21, F3690, RCK60-24B, RCK60-27B. Requires 3 Blades</p>	<p>Length 520mm Hole 28.5mm Width 65mm Thick 6mm Step 10mm</p>  <p>Use BRA-K6845 Bolt & BRA-K6846 Washer & BRA-09411 Cup</p>
<p>BR-09078 Replaces OEM K5955-34360 K5955-97530</p>	<p>Fits 60" Deck ZD1200, ZD1211, RCK60P-1200Z Deck, H26E</p> <p>Requires 3 Blades <i>Check hole size, some rear discharge decks use BR-06677 blades</i></p>	<p>Length 520mm Hole 34mm Width 65mm Thick 7mm Step 14mm</p>  <p>Use BRA-K6845 Bolt & BRA-09118 Washer & BRA-09427 Cup</p>
<p>BR-09395 Replaces OEM K5955-34360 K5955-97530</p>	<p>Fits 60" Deck - MULCH blade Zd1200, ZD1211, RCK60P-1200Z Deck, H26E</p> <p>Requires 3 Blades <i>Check hole size, some rear discharge decks use BR-09020 blades</i></p>	<p>Length 520mm Hole 34mm Width 65mm Thick 7mm Step 14mm</p> <p>NEW</p>  <p>BoronBlue™ Mulcher Blades</p> <p>Use BRA-K6845 Bolt & BRA-09118 Washer & BRA-09427 Cup</p>
<p>BR-01588 Replaces OEM 70722-34330, 70000-25006,</p>	<p>Fits Kubota, 60" Deck RC60-71H, RC60-72A, 72H, 82H, 20. Flat Blade Right Hand cut</p> <p>Requires 3 blades per set.</p>	<p>Length 517mm Hole 18mm Width 50mm Thick 6mm Step N/A</p> 
<p>BR-06020 Replaces OEM 76543-99050, 70000-25008 (flat style), 70722-34350 K5371-99040, K5371-34330</p>	<p>Fits 60" Deck Stepped & Fluted, F2100, B7510, BX2660, F2400, BX22, BX1830, G2160, G2460G, RC60-92H, 20, F20, F24, Bx24, Bx25, Bx2380, Bx2350, Bx2360. Bx2380, BX24D, Bx25. Right Hand cut Requires 3 blades per set.</p>	<p>Length 520mm Hole 23mm Width 65mm Thick 6mm Step 10mm</p>  <p>Use BRA-09120 Bolt & BRA-09119 Washer & BRA-09419 Cup</p>
<p>BR-06676 Replaces OEM 76529-34330, K5764- 34342, 76539-34372, 76550-34350, K5613-34340,</p>	<p>Fits 54" Deck Zd331, ZD321, RC54-G20, RC54-B, RC54- F19, RC54-24b, RC54-18Z, RC54-71B, FZ21, ZD18, G1900. Z421, Z422KW Stepped & Fluted, Right Hand cut Requires 3 blades per set.</p>	<p>Length 473mm Hole 28.5mm Width 65mm Thick 6mm Step 10mm</p>  <p>Use BRA-K6845 Bolt & BRA-K6846 Washer</p>
<p>BR-09421 Replaces OEM 76529-34330, K5764- 34342, 76539-34372, 76550-34350, K5613-34340,</p>	<p>Fits 54" Deck MULCH Blade Zd331, ZD321, RC54-G20, RC54-B, RC54- F19, RC54-24b, RC54-18Z, RC54-71B, FZ21, ZD18, G1900. Z421, Z422KW Stepped & Fluted, Right Hand cut Requires 3 blades per set.</p>	<p>Length 473mm Hole 28.5mm Width 65mm Thick 6mm Step 10mm</p> <p>NEW</p>  <p>BoronBlue™ Mulcher Blades</p> <p>Use BRA-K6845 Bolt & BRA-K6846 Washer</p>
<p>BR-08940 Replaces OEM K5619-34350 K5935-34360 K5351-99040</p>	<p>Fits 54" Deck RCK54P-227Z etc. ZD221, ZG223, ZG227, Zd1011, ZD321N, RCK54P-321Z etc Stepped Blade Right Hand cut Requires 3 blades per set.</p>	<p>Length 473mm Hole 23mm Width 65mm Thick 6mm Step 10mm</p>  <p>Use BRA-09120 Bolt & BRA-09119 Washer & BRA-09411 Cup</p>
<p>BR-09422 Replaces OEM K5619-34350 K5935-34360 K5351-99040</p>	<p>Fits 54" Deck MULCH Blade RCK54P-227Z etc. ZD221, ZG223, ZG227, Zd1011, ZD321N, RCK54P-321Z etc Stepped Blade Right Hand cut Requires 3 blades per set.</p>	<p>Length 473mm Hole 23mm Width 65mm Thick 6mm Step 10mm</p> <p>NEW</p>  <p>BoronBlue™ Mulcher Blades</p> <p>Use BRA-09120 Bolt & BRA-09119 Washer & BRA-09411 Cup</p>
<p>BR-06676-23 Replaces OEM K5351-34330, K5351-34342</p>	<p>Fits 54" Deck Bx2230, BX23, G2160, G2460, BX22, BX2700, RCK54-22BX, 23BX, Bx1800. Stepped & Fluted, Right Hand cut Requires 3 blades per set.</p>	<p>Length 475mm Hole 23mm Width 65mm Thick 6mm Step 10mm</p>  <p>Use BRA-09120 Bolt & BRA-09119 Washer & BRA-09419 Cup</p>

BR-09012 Replaces OEM K5617-34330, K5617-97530	54" Deck Zg127, Z125, Z251BR, Z251KH, RCK54-23ZG, RCK54P-127ZA, Z100 series Stepped & Fluted, Right Hand cut Requires 3 blades per set.	Length 473mm Hole 18mm Width 65mm Thick 6mm Step 10mm  Use BRA-09424 Bolt & BRA-09425 Washer
BR-09423 Replaces OEM K5617-34330, K5617-97530	54" Deck MULCH blade Zg127, Z125, Z251BR, Z251KH, RCK54-23ZG, RCK54P-127ZA, Z100 series Stepped & Fluted, Right Hand cut Requires 3 blades per set.	Length 473mm Hole 18mm Width 65mm Thick 6mm Step 10mm  NEW BoronBlue™ Mulcher Blades Use BRA-09424 Bolt & BRA-09425 Washer
OEM Reference numbers are used for identification only, we also encourage you to check blade dimensions prior to ordering. ASP blades are not sold as genuine.		
BR-01132 Replaces OEM 76500-34330 Must check step in blade	48" Deck RC48G, RC48-62A, 62H, G20 Stepped & Fluted, Right Hand cut Check Step Requires 3 blades per set.	Length 422mm Hole 18mm Width 50mm Thick 5mm Step 22mm 
BR-06673 Replaces OEM 76505-34330, 70722-34374, 70000-25005, K5182- 71820, 76500-34330, 70722-34330	48" Deck TG1860, G1800, G1900, BX2350, RC48G, RC48-62G, 62H Stepped & Fluted Blade Right Hand cut Requires 3 blades per set	Length 419mm Hole 18mm Width 50mm Thick 5mm Step 8mm 
BR-09259 Replaces OEM K5583-34340	48" Deck Stepped & Fluted Hi Lift Blade Right Hand cut Z411, Z723, RCK48P-400Z, RCK48p-723Z, Z412 Requires 3 blades per set	Length 421mm Hole 28.5mm Width 65mm Thick 7mm Step 17mm  Use BRA-09120 Bolt, BRA-09119 Washer
BR-09420 Replaces OEM K5583-34340	48" Deck MULCH blade Stepped & Fluted Hi Lift Blade Right Hand cut Z411, Z723, RCK48P-400Z, RCK48p-723Z, Z412 Requires 3 blades per set	Length 421mm Hole 28.5mm Width 65mm Thick 7mm Step 17mm  NEW BoronBlue™ Mulcher Blades Use BRA-09120 Bolt, BRA-09119 Washer
BR-08890 Replaces OEM K5576-34350 K5184-97532	48" Deck Hi Lift ZG222, ZD221, Pro Deck, RCK48P-222Z, Gr2010, Gr2110, Gr2120 (RCK48GR - PRO DECK - CHECK HOLE SIZE) Stepped & Hi Lift Blade Right Hand cut. Requires 3 blades per set Use BRA-09120 Bolt, BRA-09119 Washer & BRA-09411 Cup	Length 421mm Hole 23mm Width 65mm Thick 7mm Step 17mm 
BR-09311 Replaces OEM K5184-97532, K5576-34340, K5576-34350, K5576-97530, K5915-34360, K5915-97530	48" Deck. G5 Gator 592-124, Stepped & Mulch Blade. Requires 3 Per Set. ZG222, ZD221, RCK48P-222Z, Gr2010, Gr2110, Gr2120 (RCK48GR - PRO DECK - CHECK HOLE SIZE) (Blade is Oregon Gator, not ASP Boron) Use BRA-09120 Bolt, BRA-09119 Washer & BRA-09411 Cup	Length 421mm Hole 23mm Width 75mm Thick 6mm Step 16mm 

**ALL BLADES ARE SOLD AS SINGLES (INDIVIDUALLY)
PLEASE ORDER THE QUANTITY REQUIRED TO MAKE
UP A SET.**

BR-09312 Replaces OEM K5575-34330, K5575-97530, K5579-92330, K5579-92332	48" Deck. G6 Gator 392-047 Stepped & Mulch Blade. Requires 3 Per Set. TG1860, G1800, G1900, BX2350, RC48G, RC48-62G, 62H, RCK48-20ZG , RCK48GR , RCK48P-124Z, RCK48P18BX, RCK48S-222Z, RCK48S-222Z (ZG20), Zg2048, <i>(Blade is Oregon Gator, not ASP Boron)</i>	Length 421mm Hole 18mm Width 75mm Thick 6mm Step 12mm  Use BRA-09424 Bolt & BRA-09425 Washer
BR-09115 Replaces OEM K5575-34330, K5182-71840, K5575-97530, K5579-34350	48" Deck - Z100 series, T2290, Zg2048, Gr2010, RCK48P-90T etc (RCK48-GR - Not PRO Deck, check hole), RCK48-20ZG, RCK48-18BX, RCK48-222Z, RCK48P-124Z, Z231BR & KH, Z122 & Z123, Stepped & Fluted Blade, Right Hand cut. Requires 3 blades per set	Length 421mm Hole 18mm Width 65mm Thick 7mm Step 17mm  Use BRA-09424 Bolt & BRA-09425 Washer
BR-01133 Replaces OEM K5142-71820, 70712-34330, K5142-71840	Fits Kubota 44" Deck , RC44G, RCK44LT Stepped & Fluted Blade Right Hand cut Requires 3 blades per set.	Length 385mm Hole 18mm Width 50mm Thick 5mm Step 10mm 
BR-09230 Replaces OEM K5559-3433 K5700-34375 Bolt K5112-71333 Washer	42" Deck Z122R, Z231KW, RCK42P-122Z, Z232, RCK42P-90T, T2090, T2290 Stepped & Fluted Blade Right Hand cut Requires 2 blades per set	Length 546mm Hole 18mm Width 65mm Thick 6mm Step 11mm  Use BRA-09424 Bolt & BRA-09425 Washer
BR-01560 Replaces OEM 70000-25010, K5112-71920 K5111-71940	Fits Kubota 40 Deck RC40LT, T1400H, T1460, T1560, T1700H Stepped & Fluted Blade Right Hand cut Requires 2 per set.	Length 517mm Hole 18mm Width 65mm Thick 6mm Step 10mm  Use BRA-09425 Washer
BRA-K6845	BRA-K6845 Bolt suit some Blades with 28.5mm & 34mm hole Replaces OEM 76539-34372, K5651-34372, K5651-34370	
BRA-K6846	BRA-K6846 Washer suit various Replaces OEM 76550-34350 & K5651-34350, K5651-34352 - 2 Required per blade	
BRA-09120	BRA-09120 Bolt suit some Blades Replaces OEM K5371-34372	
BRA-09119	BRA-09119 Washer suit various Replaces OEM K5371-34352 - 2 Required per blade	
BRA-09118	BRA-09118 Washer suit various blades with 34mm hole. Replaces OEM K5955-34350 - 2 Required per blade	
BRA-09424	BRA-09424 Bolt suit various Replaces OEM K5700-34375	
BRA-09425	BRA-09425 Washer suit various Replaces OEM K5112-71333, K5112-71330	
BRA-09411 BRA-09419 BRA-09427	Dust cover - cup suit various blades. BRA-09411 Replaces OEM K5647-34312 BRA-09419 Replaces OEM K5651-34310 BRA-09427 Replaces OEM K5955-34310	 BRA-09411 BRA-09419 BRA-09427



MASSEY FERGUSON



Part Number	Description	
BR-07162A BR-09389 Mulch Option	72" Deck, Zt29, Zt33 BR-07162A Standard Blade BR-09389 Mulch Blade Option Stepped & Fluted Blade RH cut Requires 3 per set	Length 628mm Hole 20mm Width 60mm Thick 7mm Step 15mm  NEW
BR-0525A Replaces OEM 3606888MZ	60" Deck ZT29, ZT33 Stepped & Fluted Blade RH cut Requires 3 per set	Length 527mm Hole 20mm Width 60mm Thick 7mm Step 15mm 
BR-08963 Replaces OEM	50" Deck. ZTR Stepped & Fluted. Right Hand cut. Requires 3 blades per set <i>(Replaces the OEM 6 point star hole)</i>	Length 452mm Hole Suits the 6Pt Star Width 65mm Thick 5mm Step 24mm  BoronBlue™ Mulcher Blades
BR-115227A Replaces OEM	42" Deck MF42-20SD Mulcher Blade & Side Discharge Right Hand cut Requires 2 per set. <i>(Replaces the OEM 6 point star hole)</i>	Length 539mm Hole Suits the 6Pt star Width 70mm Thick 4mm Step N/A 
BR-115225A Replaces OEM	38" Deck MF38-15SD Mulcher Blade & Side Discharge Right Hand cut Requires 2 per set. <i>(Replaces the OEM 6 point star hole)</i>	Length 491mm Hole Suits the 6Pt star Width 70mm Thick 4mm Step N/A 

MEAN GREEN



Part Number	Description	
BR-09334 Right Hand Cut BR-09335 Left Hand Cut	74" Deck ECOTEQ / MEAN GREEN (Requires 3 Right Hand & 2 Left Hand per set) USE WITH: BRA-09337 FLAT WASHER BRA-09338 SPRING WASHER BRA-09336 BOLT	Length 413mm Hole 2 X 9.5mm & 12mm elongated Centre Hole Width 50mm Thick 5mm Step N/A  NEW
BR-09332 Replaces OEM MGUPN107	60" Deck ECOTEQ / MEAN GREEN RIVAL Side Discharge, Right Hand cut. Requires 3 USE WITH: BRA-09337 FLAT WASHER BRA-09338 SPRING WASHER BRA-09336 BOLT	Length 524mm Hole 2 X 9.5mm & 12mm elongated Centre Hole Width 50mm Thick 5mm Step N/A 
BR-09333 Replaces OEM	52" Deck ECOTEQ / MEAN GREEN Side Discharge, Right Hand cut. Requires 3 USE WITH: BRA-09337 FLAT WASHER BRA-09338 SPRING WASHER BRA-09336 BOLT	Length 457mm Hole 2 X 9.5mm & 12mm elongated Centre Hole Width 50mm Thick 5mm Step N/A  NEW

		MTD			
Part Number	Description				
BR-08963 Replaces OEM 742-04053A, 942-04053B	50" Deck. 2004 on Deep Deck Stepped & Fluted. Right Hand cut. Requires 3 blades per set <i>(Replaces the OEM 6 point star hole)</i>	Length Hole Width Thick Step	452mm Suits the 6Pt Star 65mm 5mm 24mm	 BoronBlue™ Mulcher Blades	
BR-115227A Replaces OEM 742-0616, 942-0616, 942-04312	42" Deck Mulcher Blade & Side Discharge Right Hand cut Requires 2 per set. <i>(Replaces the OEM 6 point star hole)</i>	Length Hole Width Thick Step	539mm Suits the 6Pt star 70mm 4mm N/A		
BR-115225A Replaces OEM 742-0610, 942-0610	38" Deck Mulcher Blade & Side Discharge Right Hand cut Requires 2 per set. <i>(Replaces the OEM 6 point star hole)</i>	Length Hole Width Thick Step	491mm Suits the 6Pt star 70mm 4mm N/A		
		NEW HOLLAND			
Part Number	Description				
BR-07473	72" Deck Flat Fluted Right Hand cut Requires 3 blades per set Replaces OEM: AUB163380, 163442	Length Hole Width Thick Step	632mm 23mm 65mm 8mm N/A		
BR-09019 Replaces OEM AUB163380, 163442 - has a 20mm step the BR-09019 is 10mm	72" Deck Stepped Mulcher Right Hand cut Requires 3 blades per set	Length Hole Width Thick Step	632mm 23mm 60mm 8mm 10mm	 BoronBlue™ Mulcher Blades	
BR-07473S Replaces OEM AUB163380, 163442 - has a 20mm step the BR-07473S is 10mm	72" Deck Stepped & Fluted Right Hand cut Requires 3 blades per set	Length Hole Width Thick Step	632mm 23mm 60mm 8mm 10mm		
BR-01588 Replaces OEM 162836	60" Deck Flat Fluted Right Hand cut Requires 3 blades per set	Length Hole Width Thick Step	517mm 18mm 50mm 6mm N/A		
BR-01560 Replaces OEM 162122, 914, 914A	60" Deck Fm60, CM224, CM274 Stepped & Fluted RH cut Requires 3 blades per set "Early Deck"	Length Hole Width Thick Step	517mm 18mm 65mm 6mm 10mm		

BR-06020 Replaces OEM 162122, 914, 914A	60" Deck Fm60, CM224, CM274 Stepped & Fluted Right Hand cut Requires 3 blades per set. "Late Deck"	Length 517mm Hole 23mm Width 65mm Thick 6mm Step 10mm 
BR-06677 Replaces OEM SBA645310330	60" deck, 230GM, TZ25DA Stepped & Fluted Right Hand cut Requires 3 blades per set	Length 520mm Hole 29mm Width 65mm Thick 7mm Step 14mm 
BR-09020 Replaces OEM	Mulch blade alternative to BR-06677 Requires 3 Blades	Length 520mm Hole 29mm Width 65mm Thick 7mm Step 14mm  <p style="text-align: right;">BoronBlue™ Mulcher Blades</p>
Part Number	SCAG Description	
BR-08207 Replaces OEM 481709, 48112, 48113	72" Deck Flat & Fluted Blade Right Hand cut Requires 3 blades per set. <i>(Note these are H/Duty 8mm thick blades not 1/4" like the OEM)</i>	Length 621mm Hole 16mm Width 65mm Thick 8mm Step N/A 
BR-08311 Replaces OEM 482879, 48111, 481708,	61" Deck Stepped & Fluted Blade Right Hand cut Requires 3 blades per set.	Length 536mm Hole 16mm Width 65mm Thick 6mm Step 6mm 
BR-D18037 Replaces OEM 48108, 481707, 482462, 483317 36" Deck	52" and 36" Decks Flat & Fluted Blade Right Hand cut Requires 3 per set for 52" and 2 per set for 36"	Length 457mm Hole 16mm Width 65mm Thick 6mm Step N/A 
BR-08891 Replaces OEM 48108, 481707, 482462 483317 36" Deck	52" and 36" Decks Razorback Mulcher Blade Right Hand cut Requires 3 per set for 52" and 2 per set for 36"	Length 457mm Hole 16mm Width 65mm Thick 6mm Step 4mm  <p style="text-align: right;">BoronBlue™ Mulcher Blades</p>
BR-08407 Replaces OEM 48110, 48084, 481706	48" and 32" Decks Stepped & Fluted Blade Right Hand cut Requires 3 per set for 48" and 2 per set for 32"	Length 418mm Hole 16mm Width 65mm Thick 6mm Step N/A 
BR-08895 Replaces OEM	48" and 32" Decks Stepped & Fluted Blade Right Hand cut Requires 3 per set for 48" and 2 per set for 32"	Length 418mm Hole 16mm Width 65mm Thick 6mm Step 4mm  <p style="text-align: right;">BoronBlue™ Mulcher Blades</p>

<h1>SHIBAURA</h1>			
Part Number	Description		
BR-07129 Replaces OEM	72" Deck Stepped & Fluted Blade Right Hand cut Requires 3 Blades per set.	Length 620mm Hole 23mm Width 60mm Thick 7mm Step 12mm	
BR-06677 Replaces OEM SBA645310221	60" Deck TMM60Y, ST321, ST325 Flat & Fluted Blade Right Hand cut Requires 3 Blades per set.	Length 520mm Hole 29mm Width 65mm Thick 7mm Step 14mm	
BR-01588 Replaces OEM	60" Deck SX24 Stepped & Fluted Blade Right Hand cut Requires 3 Blades per set.	Length 517mm Hole 18mm Width 50mm Thick 6mm Step N/A	
BR-06676 Replaces OEM	54" Deck SX21 Stepped & Fluted Blade Right Hand cut Requires 3 Blades per set.	Length 473mm Hole 29mm Width 65mm Thick 6mm Step 10mm	
<h1>SUPERIOR</h1>			
Part Number	Description		
BR-07503 Replaces OEM S1611, S3690	12' Trimdeck Contractor Stepped & Fluted LH cut Requires 3 per set Use BOLT KIT BRA-08067 (inc. 2 x bolts & nuts)	Length 791mm (14mm x 134mm outer holes) Hole 17.5mm Width 75mm Thick 8mm Step 20mm	
BR-07500 Replaces OEM S1631	6' Outfront Stepped & Fluted Blade LH cut Requires 3 per set Use BOLT KIT BRA-08066 (inc. 2 x bolts & nuts)	Length 632mm (11mm x 104mm outer holes) Hole 17mm Width 75mm Thick 8mm Step 20mm	
BR-07502 Replaces OEM S1508	5' Trim Deck Stepped & Fluted Blade LH cut Requires 3 per set. Use BOLT KIT BRA-08066 (inc. 2 x bolts & nuts)	Length 510mm (10mm x 104mm outer holes) Hole 16mm Width 65mm Thick 6mm Step 16mm	



TORO



Part Number	Description	
BR-09282 Replaces OEM 100-5754-03, 104-5183, 105-4089, 105-4089-03, 105-9810, 105-9810-03, 105-9810-05, 107-0235-03, 108-9026-03	4700-D, 4500-D & 3500-D WIDE AREA MOWERS. Stepped & Fluted. 30807, 30809, 30849, 30881, 30882 7 blades required BRA-09278 Anti Scalp Plate (OEM Ref 72-9361)	Length 685mm Hole 13mm Width 64mm Thick 6mm Step 11mm 
BR-09317 Replaces OEM 100-5754-03, 104-5183, 105-4089, 105-4089-03, 105-9810, 105-9810-03, 105-9810-05, 107-0235-03, 108-9026-03	4700-D, 4500-D & 3500-D WIDE AREA MOWERS. G3 Gator 96-741 Stepped & Mulch Blade. 30807, 30809, 30849, 30881, 30882 BRA-09278 Anti Scalp Plate (OEM Ref 72-9361) <i>(Blade is Oregon Gator, not ASP Boron)</i>	Length 685mm Hole 13mm Width 64mm Thick 6mm Step 11mm 
BR-08834 Replaces OEM 110-5946	Fits Toro 16' Groundsmaster 5900/5910 Stepped & Fluted Blade RH cut Requires 11 per set. Use Blade Bolt BRA-08806, Washer BRA-08809 Use BRA-09278 Anti Scalp Plate	Length 504mm Hole 13mm Width 65mm Thick 6mm Step 15mm 
BR-09122 Replaces OEM 110-5948	MULCH Toro 16' Groundsmaster 5900/5910 Stepped & Fluted Blade RH cut Requires 11 per set. Use Blade Bolt BRA-08806, Washer BRA-08809 Use BRA-09278 Anti Scalp Plate	Length 504mm Hole 13mm Width 65mm Thick 6mm Step 15mm  <p style="text-align: right;">BoronBlue™ Mulcher Blades</p>
BR-09163 Replaces OEM 130-9151	Fits Toro 16' Groundsmaster NEW model 5900/5910, 31699 Stepped & Fluted Blade RH cut Requires 11 per set. Use BRA-09278 Anti Scalp Plate Use Blade Bolt BRA-08806, Washer BRA-08809	Length 504mm Hole 13mm Width 65mm Thick 6mm Step 6mm 
BR-08695 Replaces OEM 92-5608, 107-0214 BR-08695NF OEM 110-6115-03	Toro 4000D & 4010 & 62" Decks (3 blades) 4000D & 4010 Model 30410 requires 7 per set. Also 62" Rear Discharge & recycler 7200 / 7210 BR-08695NF is a NO FLUTE OPTION Use BRA-09278 Anti Scalp Plate Use Blade Bolt BRA-08806, Washer BRA-08809	Length 552mm Hole 13mm Width 65mm Thick 6mm Step 15mm 
BR-09121 Replaces OEM 92-5608, 107-0214	MULCH blade Fits Toro 132" & 62" DECKS 4000D & 4010 Model 30410 requires 7 per set. Also 62" Rear Discharge 7200 / 7210 & 62" Recycler, requires 3 blades Use BRA-09278 Anti Scalp Plate Use Blade Bolt BRA-08806, Washer BRA-08809	Length 552mm Hole 13mm Width 65mm Thick 6mm Step 15mm  <p style="text-align: right;">BoronBlue™ Mulcher Blades</p>
BRA-09278 Replaces OEM 72-9361	Anti Scalp Plate Suits most Toro Blades with a 13mm Bolt Hole.	

LOOKING FOR BLADES TO SUIT YOUR ELECTRIC MOWER?

Talk to one of our sales team today!

Free Call 1800 253 229 or email sales@asproducts.com.au

Original Equipment (OEM) Part Number & Pictures are for reference only. ASP Blades are not sold as genuine.

Part Number

TORO Continued

<p>BR-08207 Replaces OEM 105-7711, 105-7784 <i>(Note these are H/Duty 8mm thick blades not 1/4" like the OEM)</i></p>	<p>72" Deck Side Discharge Z Master 74947, 74274, Z550-5970, Z550, Z558, Z589, Z597, 5000, 6000 & 7000 series 74918 & G3 with Holder. High Flow Blade RH cut Requires 3 per set. Flat & Fluted. Use Blade Bolt BRA-08808, Washer BRA-08807</p>	<p>Length 621mm Hole 16mm Width 64mm Thick 8mm Step N/A</p> 
<p>BR-08726 Replaces OEM 105-7784</p>	<p>72" Deck Z Master Z550-5970, Z550, Z558, Z589, Z597, G3 Mulcher Blade RH cut requires 3 per set. Use Blade Bolt BRA-08808, Washer BRA-08807</p>	<p>Length 621mm Hole 16mm Width 64mm Thick 7mm Step 6mm</p>  <p>BoronBlue™ Mulcher Blades</p>
<p>BR-08720 Replaces OEM 110-0622, 110-0621 <i>(Note these are H/Duty 8mm thick blades not 1/4" like the OEM)</i></p>	<p>72" Deck Side Discharge Groundsmaster 7200 / 7210 Models & GM360, 30360, 30361, 30362, 30363, 30364, 30365. High Lift Heavy Duty Blade Flat, RH cut Use BRA-09278 Anti-Scalp plate Requires 3 per set.</p>	<p>Length 620mm Hole 13mm Width 64mm Thick 8mm Step N/A</p> 
<p>BR-08727 Replaces OEM 110-0622, 140-4852, 110-0624</p>	<p>72" Deck Mulch Blade Groundsmaster 7200 / 7210 Models & GM360, 30360, 30361, 3300 30362, 30363, 30364, 30365. Use BRA-09278 Anti-Scalp plate Stepped Mulch RH cut, Requires 3 per set.</p>	<p>Length 620mm Hole 13mm Width 64mm Thick 7mm Step 6mm</p>  <p>BoronBlue™ Mulcher Blades</p>
<p>BR-09237 Replaces OEM 140-1238</p>	<p>72" Deck High Flow Blade RH cut 6000 series 72968, 72947, 7000 series 72274 & 7500D series 72076. Flat & Fluted. Requires 3 per set for Side Discharge deck. Blade Bolt BRA-08806, Washer BRA-08809</p>	<p>Length 620mm Hole 24mm Width 64mm Thick 6mm Step N/A</p> 
<p>BR-09277 Replaces OEM 140-1246, 140-1239</p>	<p>Fits Toro 72" 7500 Rear Discharge & 96" Deck 7500-D Model 72098 Requires 4 per set for the 96" Deck Use 2 x BR-09277 Right hand Mulch & 1 x BR-09398 for 72" REAR Discharge Blade Bolt BRA-08806, Washer BRA-08809</p>	<p>Length 621mm Hole 24mm Width 65mm Thick 7mm Step 6mm</p>  <p>BoronBlue™ Mulcher Blades</p>
<p>BR-09398 Replaces OEM 140-1245</p>	<p>72" Deck Rear Discharge LEFT HAND cut blade, suit 7500 Rear Discharge Flat & Fluted. Use 2 x BR-09277 Right hand Mulch & 1 x BR-09398. Blade Bolt BRA-08806, Washer BRA-08809</p>	<p>Length 620mm Hole 24mm Width 64mm Thick 6mm Step N/A</p>  <p>NEW</p>
<p>BR-08515 Replaces OEM 110-0621</p>	<p>72" Deck Groundsmaster 3280 & 3320 Side Discharge. Model 3320, 30368 Stepped & Fluted Blade RH cut. Requires 3 per set. Use Blade Bolt BRA-08806, Washer BRA-08809 BRA-09278 Anti-Scalp Plate</p>	<p>Length 618mm Hole 13mm Width 65mm Thick 6mm Step 6mm</p> 
<p>BR-06271 Replaces OEM 93-4982, 108-1958, 85-6040 121-5347, 125-9444</p>	<p>72" Deck - Rear Discharge Groundsmaster / Z Master, Guardian Recycler, 217D, 220D, 957D, 3320, 3280 Z597 & 7200 , Gm360. Stepped & Fluted Blade RH cut 3 per set. Use BRA-09278 Anti Scalp Plate Use Bolt BRA-08806, Washer BRA-08809</p>	<p>Length 639mm Hole 13mm Width 65mm Thick 6mm Step 6mm</p> 
<p>BR-06271NF Replaces OEM 112-9586-03</p>	<p>72" Deck - Rear Discharge, NO FLUTE Groundsmaster / Z Master, Guardian Recycler, 217D, 220D, 957D, 3320, 3280 Z597 & 7200 , Gm360. Stepped & Fluted Blade RH cut 3 per set. Use BRA-09278 Anti Scalp Plate. Use Bolt BRA-08806, Washer BRA-08809</p>	<p>Length 639mm Hole 13mm Width 65mm Thick 6mm Step 6mm</p> 







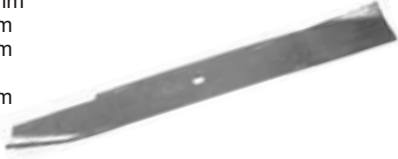

Part Number

TORO Continued

<p>BR-08210 Replaces OEM 105-7715, 105-7718, 105-7716, 103-0301, 133-2127, 115-9649</p>	<p>60" Deck 74958, 74950, 74955, 74945, 75318TA Z500, 74246-Z557, G3, Z587L, Z588E, Z597 & Z593, Z528, 5000, 6000 & 7000 series 74915 & 74930, Z558 with holder. Titan Zx6050 & Hd2000, 74946, 74285, 74265. Flat & Fluted R/H cut Requires 3 per set. Use Blade Bolt BRA-08808, Washer BRA-08807</p>	<p>Length 520mm Hole 16mm Width 63mm Thick 6mm Step N/A</p> 
<p>BR-08910 Replaces OEM 105-7715, 105-7718, 105-7716, 103-0301, 105-7777, 105-8777, 133-2157</p>	<p>60" Deck Mulcher Z500, 74246-Z557, G3, Z587L, Z588E, Z597 & Z593, Z528, Z558 with holder. Requires 3 per set. Use Blade Bolt BRA-08808, Washer BRA-08807</p>	<p>Length 520mm Hole 16mm Width 63mm Thick 6mm Step N/A</p> 
<p>BR-08516 Replaces OEM 110-4701 110-4702 High 110-4703 Mulch</p>	<p>60" Deck Groundsmaster 3280 & 3320, 31970 7200 / 7210 Flat & Fluted Blade RH cut Requires 3 per set Use BRA-09278 Anti-Scalp plate</p>	<p>Length 520mm Hole 13mm Width 63mm Thick 6mm Step</p> 
<p>BR-09220 Replaces OEM</p>	<p>60" Deck Mulcher Groundsmaster 3280 & 3320, 7200 / 7210 Flat & Fluted Blade RH cut Requires 3 per set Use BRA-09278 Anti-Scalp plate</p>	<p>Length 520mm Hole 13mm Width 63mm Thick 6mm Step N/A</p> 
<p>BR-09235 Replaces OEM 140-1240 Blade 109-9220 Bolt / Washer</p>	<p>60" Deck Flat & Fluted R/H cut 3000 series 72950, 72936 6000 series 72960, 72967, 72946 7000 series 72267 Use Blade Bolt BRA-08806, Washer BRA-08809 Requires 3 per set</p>	<p>Length 520mm Hole 24mm Width 63mm Thick 6mm Step N/A</p> 
<p>BR-09240 Replaces OEM 140-1241 Blade 109-9220 Bolt / Washer</p>	<p>60" Deck REAR DISCHARGE, Right Hand cut - requires 2 & 1 x BR-09241 Left hand 5000 series 72943 7500D 72028, 7510 BRA-08806 Blade Bolt BRA-08809 Washer</p>	<p>Length 520mm Hole 24mm Width 63mm Thick 6mm Step N/A</p> 
<p>BR-09241 Replaces OEM 140-1244 109-9220 Bolt / Washer</p>	<p>60" Deck REAR DISCHARGE Deck Flat & Fluted Blade Left Hand cut, use with 2 x BR-09240 blades. 7500, 72028, 7510 BRA-08806 Blade Bolt BRA-08809 Washer</p>	<p>Length 520mm Hole 24mm Width 65mm Thick 6mm Step N/A</p> 
<p>BR-09242 Replaces OEM 115-9650 Blade 115-2454</p>	<p>54" Deck Side Discharge Time Cutter & Titan, 75212, 75312TA, 74740, 75317TA Flat & Fluted RH cut Requires 3 blades per set</p>	<p>Length 475mm Hole 16mm Width 65mm Thick 5mm Step N/A</p> 
<p>BR-09299 Replaces OEM 539112078, 573953001, 577146101</p>	<p>54" Decks Flat Blade. G3 Gator 96-803 Time Cutter & Titan, 75212, 75312TA Flat & Fluted RH cut <i>(Blade is Oregon Gator, not ASP Boron)</i></p>	<p>Length 475mm Hole 16mm Width 65mm Thick 5mm Step N/A</p> 

ALL BLADES ARE SOLD AS SINGLES (INDIVIDUALLY) PLEASE ORDER THE QUANTITY REQUIRED TO MAKE UP A SET.

<p>BR-09234 Replaces OEM 140-1242 Blade 109-9220 Bolt / Washer 109-6873</p>	<p>52" Deck - 3000 & 7000, 72949 & 72266 Flat & Fluted Blade RH cut Requires 3 per set,</p>	<p>Length 457mm Hole 24mm Width 63mm Thick 6mm Step N/A</p>	
<p>BR-09245 Replaces OEM 140-4859 Blade 109-9220 Bolt / Washer</p>	<p>52" Deck - 3000 & 7000, 72949 & 72266 Flat & Fluted Blade RH cut Requires 3 per set,</p>	<p>Length 457mm Hole 24mm Width 63mm Thick 6mm Step N/A</p>	 <p>BoronBlue™ Mulcher Blades</p>
<p>BR-D18037 Replaces OEM 106-2174, 105-7781, 55-4210, 40-3760, 108-1117, 105- 7779, 133-2134</p>	<p>52" Deck - Time Cutter 74806, 74906, 74955, ZX525, Z593D 453 Model & GM117. 74505, 74466, 74906, 74949, 77290, 3000 & 5000 & Titan. Flat & Fluted Blade RH cut Requires 3 per set & 2 for 36" GRANDSTAND Use BRA-08938 Bolt & BRA-08807 washer</p>	<p>Length 457mm Hole 16mm Width 65mm Thick 5mm Step N/A</p>	
<p>BR-08891 Replaces OEM 106-2174, 105-7781, 105-7779, 110-0409</p>	<p>52" Deck - MULCH. Time Cutter 74806, 74906, 74955, ZX525, Z593D 453 Model & GM117. 74505, 74466, 74906, 74949, 77290, 3000 & 5000 & Titan. Mulcher Blade RH cut Requires 3 per set, Use BRA-08938 Bolt & BRA-08807 washer</p>	<p>Length 457mm Hole 16mm Width 63mm Thick 6mm Step N/A</p>	 <p>BoronBlue™ Mulcher Blades</p>
<p>BR-08980 Replaces OEM 110-6837 115-5059 140-5134</p>	<p>50" Deck, 3 Blades & 34" Deck, 2 Blades MX5050 & MX 3450 Timecutter Z5000 SERIES 74370 & 75730TA Flat & Fluted Blade RH cut</p>	<p>Length 445mm Hole 16mm Width 60mm Thick 6mm Step 3mm</p>	
<p>BR-09233 Replaces OEM 140-1243 Blade 109-9220 Bolt / Washer</p>	<p>48" Deck 3000 series, 72952. 4000, 74000 & Grandstand, 74000TA Flat & Fluted Blade RH cut Requires 3 per set. Use Blade Bolt BRA-08806, Washer BRA-08809</p>	<p>Length 418mm Hole 24mm Width 63mm Thick 6mm Step N/A</p>	
<p>BR-09246 Replaces OEM 140-1243 Blade 140-4863 109-9220 Bolt / Washer</p>	<p>48" Deck Mulch 3000 series, 72952. 4000, 74000 & Grandstand, 74000TA Flat Mulch Blade RH cut Requires 3 per set. Use Blade Bolt BRA-08806, Washer BRA-08809</p>	<p>Length 418mm Hole 24mm Width 63mm Thick 6mm Step N/A</p>	
<p>BR-08407 Replaces OEM 107-3192, 107-3193 107-3194, 133-2137, 117-7277</p>	<p>48" Deck Titan HD 2000 series, Z master etc 74412-Z400, & 74417 Z450, 3000, 77280 G3 Z Master. ZX4820, Zx4800 Flat & Fluted Blade RH cut Requires 3 per set. Use Blade Bolt BRA-08808, Washer BRA-08807</p>	<p>Length 418mm Hole 16mm Width 63mm Thick 6mm Step N/A</p>	
<p>BR-08895 Replaces OEM 107-3192, 107-3193 107-3194</p>	<p>48" Deck 74412-Z400, & 74417 Z450, Zx4800 & ZX4820, 3000, G3 Z Master Mulcher Blade Requires 3 per set. Use Blade Bolt BRA-08808, Washer BRA-08807</p>	<p>Length 418mm Hole 16mm Width 63mm Thick 6mm Step N/A</p>	 <p>BoronBlue™ Mulcher Blades</p>

<p>BR-08546 LH Replaces OEM 130-2861</p> <p>BR-08547 RH Replaces OEM 130.2862</p>	<p>48" Deck 8000 Series & Navigator Stepped & Fluted Require: 1 x BR-08546 & 1 x BR-08547 For Catcher</p>	<p>Length 640mm (7.5mm holes @ 76mm centres) Hole 23mm Width 60mm Thick 5mm Step 20mm</p> 
<p>BR-08463 Replaces OEM 106-2247, 106-8744 131-3939-03 (High Lift)</p>	<p>42" Deck Mx4260, Z4220, Time Cutter 74403-Z420, 74403-16-42Z, Z4200 Flat & Fluted Blade RH cut Requires 2 per set</p>	<p>Length 548mm Hole 16mm Width 60mm Thick 5mm Step 12mm</p> 
<p>BR-08504 LH Replaces OEM 130-2860</p> <p>BR-08505 RH Replaces OEM 130-2859</p>	<p>42" Deck 8000 Series & Navigator Stepped & Fluted Require: 1 x BR-08504 & 1 x BR-08505 For Catcher</p>	<p>Length 560mm (7.5mm holes @ 76mm centres) Hole 23mm Width 60mm Thick 5mm Step 20mm</p> 
<p>BR-08891 Replaces OEM 133-2134</p>	<p>36" GRANDSTAND - MULCH BLADE 74534 models Mulcher Blade RH cut Requires 2 per set, (For Standard Blade use - BR-D18037)</p>	<p>Length 457mm Hole 16mm Width 63mm Thick 6mm Step N/A</p> 
<p>BR-09297 Replaces OEM 116-6358-03</p>	<p>30" Deck TimeMaster 20199 , 20200 , 2014 30" cut TurfMaster Walk Behind Mowers Step Mulch Blade RH cut Requires 2 per set</p>	<p>Length 389mm Centre Hole 16mm (2 x Outer Holes 7.5mm) Width 64mm Thick 4mm Step 11mm</p> 
<p>Part Number</p>	<p>VENTRAC</p> <p>Description</p>	
<p>BR-09015 Replaces OEM 79.0048</p>	<p>Suits Ventrac Mower Tough Cut Flat, Double edge blade LH & RH cut</p>	<p>Length 584mm Hole 13mm Width 65mm Thick 8mm Step N/A</p> 
<p>Part Number</p>	<p>WALKER</p> <p>Description</p>	
<p>BR-08222 LH Replaces OEM 7705-2</p> <p>BR-08223 RH Replaces OEM 7705-1</p>	<p>48" Deck 08222 LEFT Hand & 08223 RIGHT Hand, Stepped & Fluted LH cut Require: 1 x BR-08223 & 1 x BR-08222 For GHS <i>Use BRA-08239 Shear bolt & BRA-08240 nut</i></p>	<p>Length 640mm (5.5mm holes @ 76mm centres) Hole 16mm Width 60mm Thick 5mm Step 20mm</p> 
<p>BR-355032 LH Replaces OEM 5705-4</p> <p>BR-355024 RH Replaces OEM 5705-3</p>	<p>42" Deck 355032 LEFT Hand & 355024 RIGHT Hand. Stepped & Fluted LH cut Require 1 x BR-355032 & 1 x BR-355024 for GHS <i>Use BRA-08239 Shear bolt & BRA-08240 nut</i></p>	<p>Length 560mm (5.5mm holes @ 76mm centres) Hole 16mm Width 60mm Thick 5mm Step 20mm</p> 

LENGTH	HOLE	STEP	WIDTH	THICK	PART NUMBER	LENGTH	HOLE	STEP	WIDTH	THICK	PART NUMBER
372	SPT STAR	0	65	5	BR-08957	520	28.5	14	65	7	BR-06677
379	18	0	63	5	BR-09303	520	28.5	10	65	6	BR-09386
385	18	10	50	5	BR-01133	520	16	0	63	6	BR-08210
389	16	11	64	4	BR-09297	520	24	0	63	6	BR-09235
397	16	0	70	5	BR-09307	521	23	0	65	6	BR-06253
412	SPT STAR	0	65	5	BR-08956	521	12	0	50	5	BR-09332
413	16	0	75	6	BR-09304	527	20	15	60	7	BR-0525A
413	12	0	50	5	BR-09334	532	16	6	65	6	BR-D18036
413	12	0	50	5	BR-09335	533	SPT STAR	0	75	4	BR-09300
418	16	0	65	6	BR-08407	529	23	10	65	8	BR-128485M
418	16	0	65	7	BR-08895	529	23	10	65	8	BR-128485
420	18	22	50	5	BR-01132	535	SPT STAR	0	57	4	BR-08224
420	18	10	65	6	BR-09312	536	16	6	65	6	BR-08311
421	29	17	65	7	BR-09259	539	6PT STAR	0	70	4	BR-115227A
421	29	17	65	7	BR-09420	543	20	0	65	4.5	BR-09183
422	23	16	75	6	BR-09311	543	7PT STAR	0	65	4	BR-08756
422	18	17	65	7	BR-09115	545	17	0	65	5	BR-20249
422	18	8	65	5	BR-06673	546	18	11	65	6	BR-09230
422	23	17	65	7	BR-08890	548	16	0	60	5	BR-08463
424	SPT STAR	0	64	5	BR-09319	550	13	15	65	6	BR-08695
430	21	7	65	5	BR-127500	550	13	15	65	6	BR-08695NF
430	23	17	65	6	BR-08701	555	23	8	65	8	BR-08560
432	7PT STAR	6	63	5	BR-09298	560	23	20	60	6	BR-08546
432	19	11	75	6	BR-09313	560	23	20	60	6	BR-08547
452	6PT STAR	24	65	5	BR-08963	560	16	20	60	5	BR-355024
445	16	3	60	6	BR-08980	560	16	20	60	5	BR-355032
451	SPT STAR	0	75	4	BR-09306	581	SPT STAR	8	70	4	BR-09301
457	16	4	65	5	BR-D18037	606	16	0	65	6	BR-08954
457	16	0	65	7	BR-08891	618	13	6	65	6	BR-08515
457	12	0	50	5	BR-09333	620	24	0	64	6	BR-09237
457	24	0	63	6	BR-09234	621	24	6	65	6	BR-09277
469	SPT STAR	12	64	5	BR-09302	620	13	0	63	8	BR-08720
470	16	0	65	6	BR-08951	620	13	10	65	6	BR-08727
470	23	10	65	6	BR-09422	620	23	12	60	7	BR-07129
470	23	10	65	6	BR-08940	621	16	10	65	6	BR-08726
472	29	10	65	6	BR-06676	621	16	0	65	8	BR-08207
472	29	10	65	6	BR-09421	621	16	10	65	6	BR-08726
473	21	7	65	5	BR-330365	622	34	14	65	7	BR-09077
473	23	10	65	6	BR-06676-23	622	28.5	15	75	7	BR-08826
473	18	10	65	6	BR-09012	622	28.5	14	65	7	BR-07462
473	18	10	65	6	BR-09423	622	28.5	14	65	7	BR-08703
475	16	0	65	5	BR-09242	622	34	15	75	7	BR-09085
480	20	10	65	6	BR-08962	628	20	15	60	7	BR-07162A
481	20	12	75	6	BR-09309	628	20	15	65	7	BR-09389
483	23	7	65	5	BR-08470	630	16	6	65	6	BR-08217
483	23	10	75	6	BR-09310	630	23	10	60	8	BR-07473S
489	SPT STAR	0	65	5	BR-08957	632	23	0	65	8	BR-07473
494	18	7	75	5	BR-330397	632	17	20	75	8	BR-07500
494	18	7	65	5	BR-330290	634	23	15	75	7	BR-08772
495	18	10	75	6	BR-09308	634	23	7	65	8	BR-08466
504	13	15	65	6	BR-08834	639	13	6	65	7	BR-06271
504	13	6	65	6	BR-09163	639	13	6	65	6	BR-06271NF
510	16	16	65	6	BR-07502	640	23	23	60	6	BR-08504
517	18	0	50	6	BR-01588	640	23	23	60	6	BR-08505
517	23	7	65	6	BR-06020	640	16	23	60	6	BR-08222
517	18	10	65	6	BR-01560	640	16	23	60	6	BR-08223
518	13	6	65	6	BR-08516	685	13	11	64	6	BR-09317
520	16	0	65	6	BR-08952	685	13	11	65	6	BR-09282
520	16	0	65	7	BR-08910	791	17.5	20	75	8	BR-07503
520	34	14	65	7	BR-09395						
520	34	14	65	7	BR-09078						

EDGER BLADES

Part Number	Description	
BM-802310	Edger blade. OEM Ref L129 Suits Little Wonder, Kawasaki, MTD, Masport, Toro etc. Blades are 250mm long, 45mm wide, 3mm thick and have a 13mm hole.	
BM-802720	Edger blade. OEM Ref ME63222G Suits Victa etc. Blades are 250mm long, 50mm wide, 3mm thick and have a 16mm hole.	
BM-09137	Edger blade. Suits Various. Blades are 300mm long, 50mm wide, 3mm thick and have a 16mm hole.	
BM-08908	Edger blade. Stihl OEM 41337134102 Suits Ryobi, Shindaiwa, Stihl & Husq. Combi ECA850 & ESA850 Blades are 195mm long, 50mm wide, 3mm thick and have a 25mm hole.	
BM-08565	Edger blade to suit select Professional Edgers Ref 43105 One piece heavy duty steel blade. 2.5mm thick steel 265mm long x 13mm hole x 45mm wide	
BM-08326	Edger blade to suit select Professional Edgers Ref 43105 One piece extra heavy duty BORON steel blade. 3mm thick steel 265mm long x 13mm hole x 45mm wide	
ASP after market edger blades are not sold as original equipment.		
		
ASP-1069	Gyral Edger Disc. OEM Ref T1679 Disc's are 13" diameter, 52mm round centre hole with 5 X 7mm radial holes at 94mm PCD. 27mm Dish Depth. BORON steel.	 

LIGHTNING TRIMMER LINE

Professional Grade trimmer line for ultimate performance & durability!

ASP heavy duty 'Lightning Line' is the perfect choice for commercial operators, offering resistance to fraying, welding & breakage. Delivering efficient cuts at affordable pricing.

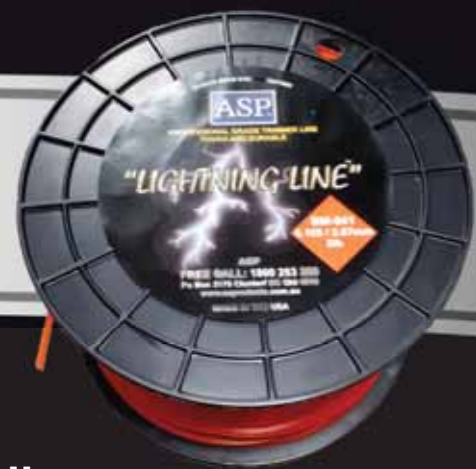

Available in 1lb, 3lb & 5lb rolls
2.4mm, 2.7mm, 3.0mm, 3.3mm &
4.0mm

Made in the USA



ROUND

BM-826	2.0mm	1lb	90mtr
BM-813	2.4mm	1lb	80mtr
BM-814	2.7mm	1lb	70mtr
BM-815	3.0mm	1lb	54mtr
BM-816	2.4mm	3lb	256mtr
BM-817	2.7mm	3lb	210mtr
BM-818	3.0mm	3lb	163mtr
BM-819	2.4mm	5lb	427mtr
BM-820	2.7mm	5lb	350mtr
BM-821	3.0mm	5lb	272mtr
BM-822	3.3mm	5lb	269mtr
BM-860	4.0mm	5lb	150mtr



DIAMOND

BM-834	2.4mm	1lb	70mtr
BM-835	2.7mm	1lb	66mtr
BM-836	3.0mm	1lb	54mtr
BM-837	2.4mm	3lb	241mtr
BM-838	2.7mm	3lb	198mtr
BM-839	3.0mm	3lb	163mtr
BM-840	2.4mm	5lb	401mtr
BM-841	2.7mm	5lb	329mtr
BM-842	3.0mm	5lb	273mtr
BM-843	3.3mm	5lb	240mtr
BM-862	4.0mm	5lb	140mtr

F-ONE SERIES BUMP FEED HEADS

Made in Italy - Professional Grade

✓ INNOVATIVE "LINE SHIELDER"

Stops the line from breaking at the eyelets, therefore preventing it from going back inside the head, assuring a continuous job without interruption.

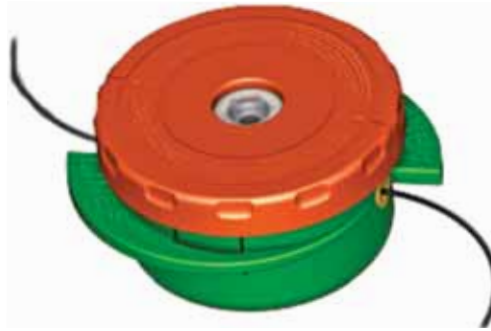

LINE NEVER BREAKS AT THE EYELET!

✓ RC SYSTEM: EASY RETOOLING

Simply line up the arrow with the eyelet, then thread the line through the head, making sure that both lengths are equal on either side. Just by twisting the head the line is wound onto the spool. It's very easy, no need to take the head apart!

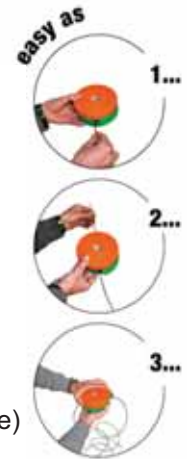

... GO!

PART NUMBER THREAD SIZE

F-ONE 396 (4 INCH) HEADS

BM-08897	8X1.25MLH
BM-08898	10X1.25MLH
BM-08899	8X1.25FLH
BM-08900	10X1.00FLH
BM-08901	10X1.25FLH
BM-09374	12X1.25FLH
BM-09375	12X1.50FLH
BM-09376	12X1.75FLH

BM-09377	UNIVERSAL FIT (Fits like a cutting blade)
BM-101279	Replacement Face for above Heads

F-ONE 596 (4 1/2" INCH) HEADS

BM-09378	596 SERIES LARGE HEAD 10X1.00FLH
BM-09379	596 SERIES LARGE HEAD 10X1.25FLH

Max line size 4.0mm (Round)

UNIVERSAL BUMP FEED HEADS

ASP SPEED FEED STYLE 4"



BM-08900SF

- Loads in 30 seconds
 - Rugged semi-matic head for medium to h/duty applications
 - Inner wall reduces amount of dirt inside head
 - Large, durable eyelets enhance line life
 - Line tensioning system with split spool reduces vibration
 - Holds 10 feet of .095" line (Max line size 2.7mm)
- Fits: Most straight shaft brushcutters.
Diameter: 4"

Kit Consists of:

- 1 x M10 x 1.25 LHF
- 1 x M10 x 1.00 LHF
- 1 x M8 x 1.25 LHF
- 1 x Stud 8mm x 1.25 LHM
- 1 x Stud 7mm x 1.00 LHM

BM-08900SF-B
REPLACEMENT COVER
(WILL ONLY FIT ASP
HEADS)

ASP SPEED FEED STYLE 4.5"



BM-09280SF

- Loads in 30 seconds
 - Rugged semi-matic head for medium to h/duty applications
 - Inner wall reduces amount of dirt inside head
 - Large, durable eyelets enhance line life
 - Line tensioning system with split spool reduces vibration
 - Holds 20 feet of .095" line (Max line size 2.7mm)
- Fits: Most straight shaft brushcutters.
Diameter: 4 1/2", 114.3 mm

Kit Consists of:

- 1 x M10 x 1.25 LHF
- 1 x M10 x 1.25 LHF
- 1 x Stud 8mm x 1.25 LHM
- 1 x Stud 7mm x 1.00 LHM
- 1 x M10 x 1.00 LHF

BM-09280SF-B
REPLACEMENT COVER
(WILL ONLY FIT ASP
HEADS)

TRIMMER HEADS & LITTER TOOLS

BM-08091

Manual Feed Trimmer Head

BM-08091 SEMI-AUTOMATIC TRIMMER HEAD. The BM-08091 represents a new generation of manual heads. (There's no need to loosen the knob to lengthen the line). Made in Italy. Please specify which arbour you require when ordering. (suits Straight Shaft only)



Part #	Size
BM-102480	8 x 1.25 FEMALE LEFT HAND (COMES STANDARD IN HEAD)
If you require other sizes please specify / order the following:	
BM-102481	10 x 1.00 FEMALE LEFT HAND
BM-102482	10 x 1.00 FEMALE LEFT HAND - (STIHL MODELS)
BM-102483	10 x 1.25 FEMALE LEFT HAND
BM-102489	8 x 1.25 MALE LEFT HAND
BM-102490	10 x 1.25 MALE LEFT HAND
BM-102487	12 x 1.75 FEMALE LEFT HAND



Refer to application list over the page for correct arbour size.



BM-08019

TANAKA STYLE ALLOY TRIMMER HEAD.
The BM-08019 head is a universal multi fit head which mounts the same as you would a cutting blade. 2 outlets. 14mm hole.
Ref: CH-100



BM-08027

TANAKA STYLE ALLOY TRIMMER HEAD.
The BM-08027 head is a universal multi fit head which mounts the same as you would a cutting blade. Spool type head with 4 outlets. 25mm hole.
Ref: CH-300



33" (84cm) & 40" (100cm) long, large jaw style Litter Picker.

33" (84cm) Industrial-quality, durable, lightweight, versatile pick-up tool, made with a sturdy aluminum shaft, and high impact plastic handle. Pick up a coin or a 2 litre bottle. Widest Jaw opening on the market.

BM-08848 84cm long
BM-08849 100cm long



32" (80cm) & 40" (100cm) long, rubber suction style Litter Picker.

Lightweight aluminum shaft, high impact plastic handle, rubber cups that can pick up a coin or a brick. Heavy duty, durable and lightweight.



BM-08462 80cm long
BM-08499 100cm long
BM-08711 Replacement Grip Rubber Cups (sold as a pair)

QUALITY AT COMPETITIVE PRICES!

ASP supply quality wear resistant parts at extremely competitive prices. All our products come with a 3 month Replacement Parts Warranty (refer to inside of back page for conditions) and are backed by a \$20m Product Liability Insurance.

ASP ships Australia wide with fast & reliable freight companies and pass on our excellent freight rates to you. All items are despatched from our Brisbane warehouse and stocked items leave the same day they are ordered (if order is received prior to 1pm).

Call 07 3881 3464 or email sales@asproducts.com.au

ARBOUR APPLICATION CHART

BRUSHCUTTER MAKE & MODEL	ARBOUR SIZE		BRUSHCUTTER MAKE & MODEL	ARBOUR SIZE
CRAFTSMAN (MSAA)			HONDA	
KAWASAKI 2400, 2410	8 x 1.25mm LHF		UMK422, UMK425, UMK435	10x 1.25mm LHF
KIORITZ 206F	8 x 1.25mm LHF			
MITSUBISHI 1600, 1605, 1810	8 x 1.25mm LHF		HUSQVARNA	
636-79534C, 218151-2816	10 x 1.25mm LHF		16R, 22R, 24R	8 x 1.25mm LHM
636-795451, 795454, 796231	10 x 1.00mm LHF		24R, 25R (Prior 86)	8 x 1.25mm LHM
636-796232, 796233, 796234	10 x 1.00mm LHF		24R (After S/N 603702)	8 x 1.25mm LHF
636-796242, 636-796243	10 x 1.00mm LHF		225L, 225RI, (1995)	10 x 1.25mm LHF
79534C	10 x 1.25mm LHM		545 FR, FX, FXT, RX, RXT	12 x 1.75mm LHF
9-89658L2, 979551C, 979552C	10 x 1.25mm LHF		JONSERED	
			BR SERIES, BR400, BR450	8 x 1.25mm LHM
ECHO - KIORITZ			LR-200, LR-220B, LR-220L,	8 x 1.25mm LHM
SRM 1400, 140DA, 190,	10 x 1.25mm LHF		LR-260B, LR-300	8 x 1.25mm LHM
200DA, 200BE	10 x 1.25mm LHF		LR-320, LR-400, LR-420,	8 x 1.25mm LHM
SRM 200DB, 200AE, 200CE, 300E	10 x 1.25mm LHF		LR-450, LR-460	8 x 1.25mm LHM
SRM 250E, 2510	10 x 1.25mm LHF		TIGER 40	8 x 1.25mm LHM
SRM 300, 300AE, 300A/E, 303E	10 x 1.25mm LHF			
SRM 302DBX, 400AE,	10 x 1.25mm LHF		KAWASAKI	
400BE, 402DE	10 x 1.25mm LHF		TT30R	10 x 1.25mm LHF
SRM 501DE, 1400, 140DA,	10 x 1.25mm LHF		TD & TG 24	8 x 1.25mm LHF
1500, 1501	10 x 1.25mm LHF			
SRM 2200, 2201, 2205, 2210	10 x 1.25mm LHF		McCULLOCH	
SRM 2300, 2301, 2400, 2410	10 x 1.25mm LHF		MAC22, MAC23	8 x 1.25mm LHM
SRM 2500, 2501, 2501S, 2502, 3000	10 x 1.25mm LHF		MAC57	10 x 1.25mm LHM
SRM 3001, 3010, 3800, 4600	10 x 1.25mm LHF		MAC100A, MAC270,	10 x 1.25mm LHF
STM3000, 3010	10 x 1.25mm LHF		MAC90A, 95A, 95 PRO	10 x 1.25mm LHF
RM 303E	10 x 1.25mm LHF		100A, EB240, PSII	10 x 1.25mm LHF
GT1100, 1100A, GT2101, 2103	10 x 1.25mm LHF		85A, 85S, 85SL, 90, 95, 95A, 99A	10 x 1.25mm LHF

BRUSHCUTTER MAKE & MODEL	ARBOUR SIZE		BRUSHCUTTER MAKE & MODEL	ARBOUR SIZE
McCULLOCH cont			STIHL cont	
EB-IIIVSL	10 x 1.25mm LHF		FS74, FS76 10 x 1.00mm LHF	10 x 1.00mm LHF
EB-280, EB-285BC,	10 x 1.25mm LHF		FS90, FS110, FS130, FS91	10 x 1.00mm LHF
EB-285BCS, FM-3000	10 x 1.25mm LHF		4 mix models,	10 x 1.00mm LHF
PRO-SCRAPER 1, II, IIHD, IV	8 x 1.25mm LHM		FS25-4, FS65-4,	10 x 1.00mm LHF
PRO-SCRAPER EB I, II, III, IV, V	10 x 1.25mm LHF		FS81AVE, FS81AVRE,	10 x 1.00mm LHF
SM100	10 x 1.25mm LHF		FS86AVE, FS86AVRE	10 x 1.00mm LHF
TITAN 2300, 2300A/V	10 x 1.25mm LHF		FR106, FS106, FS106AVE	10 x 1.00mm LHF
TITAN 2400, 2500, 2500A/V	10 x 1.25mm LHF			
TITAN 2250, 2310, 2360,	10 x 1.25mm LHF		TANAKA	
2560av, 2565av	10 x 1.25mm LHF		AST-5000	10 x 1.25mm LHM
TITAN 3000, 3900	10 x 1.25mm LHF		AST-700, AST-7000, AST-7000S	8 x 1.25mm LHM
			BC-350, BC-400	10 x 1.25mm LHM
POULAN			LT-210, LT-210E, NC-301	10 x 1.25mm LHF
900	10 x 1.25mm LHF		SUM-301, SUM-321	8 x 1.25mm LHM
1000	10 x 1.50mm LHF		TB-220, TB-220E	8 x 1.25mm LHM
150, 200	10 x 1.25mm LHF		TBC-160	8 x 1.25mm LHF
2620, 2820	10 x 1.25mm LHF		TBC-16D, TBC-215	8 x 1.25mm LHM
			TBC-202, TBC-205, TBC-210	8 x 1.25mm LHF
RYOBI			TBC-2110, TBC-2510	8 x 1.25mm LHF
GRASS HORNET/WEED HORNET	8 x 1.25mm LHF		TBC-220, TBC-220SS,	8 x 1.25mm LHM
RGH-600	8 x 1.25mm LHF		TBC-232, TBC-233	8 x 1.25mm LHM
RSH-1100MK2	10 x 1.25mm LHM		TBC-240, TBC250,	8 x 1.25mm LHM
SCRUB HORNET RHS900,	8 x 1.25mm LHM		TBC-262, TBC-265	8 x 1.25mm LHM
RSH900HB	8 x 1.25mm LHM		TBC-301, TBC-322,	8 x 1.25mm LHM
			TBC-325 (Older Model)	8 x 1.25mm LHM
SHINDAIWA			TBC-300, TBC-321, TBC-322,	10 x 1.25mm LHM
B40, C35, C350, RC45, BP35,	10 x 1.25mm LHM		TBC-355, TBC-373	10 x 1.25mm LHM
BP45, B450	10 x 1.25mm LHM		TBC-422C, TBC-425,	10 x 1.25mm LHM
BP35, C25, 45, C25, 27, F18, F20,	8 x 1.25mm LHM		TBC-500, TBC-501	10 x 1.25mm LHM
T260, C260, T270, C270, T350	8 x 1.25mm LHM		TBC-425, TBC-4000, TBC-4500	10 x 1.25mm LHM
R20, 25, 35, T25, T250, T260	8 x 1.25mm LHM		TN-3100, TN-3300 (Brain)	10 x 1.25mm LHM
STIHL			TORO	
FS40, FS44, FS55, FS90, FS110,	10 x 1.00mm LHF		1000, 2000, 2100	10 x 1.25mm LHF
FS85, FS120, FS200	10 x 1.00mm LHF		30900, 30910, 30920	10 x 1.25mm LHF
FS50, FS50E, FS51, FS60, FS61,	8 x 1.25mm LHM		51550, 51603, 51604, 51606,	10 x 1.25mm LHF
FS65, FS80 (old), FS90 (old)	8 x 1.25mm LHM		51607, 51608	10 x 1.25mm LHF
FS52AVRE, FS62AVRE, FS66AVE	10 x 1.00mm LHF		CL-700, CL-2100	10 x 1.25mm LHF
FS56AVE, FS56AVRE,	10 x 1.00mm LHF		TC SERIES	10 x 1.25mm LHF
FS66AVE, FS66AVRE	10 x 1.00mm LHF			

How to return goods

Parts are not sold on a trial basis and can only be returned if fully resalable, and are returned within 21 days from date of purchase. Parts returned after 21 days may incur a restocking fee and credit will be at our discretion. You must contact us prior to making a return. When returning goods please ensure your details are clearly marked on packaging or include your proof of purchase with the returned goods.

Shipping Discrepancies / Damages

(Incorrect parts, shortages, overage & damaged products) must be reported within 24 hours of receipt. Damages must be reported immediately. All external damages should be reported to the carrier and noted on the delivery / shipping document when signing for receipt of goods. Any damages not reported within 24 hours cannot be adjusted / credited.

Please check that the correct number of parcels have been received before signing for receipt of goods.

We stock all of our parts in a 1200m² warehouse in Clontarf QLD, and operate a fully computerised system that will ensure your orders are promptly and efficiently despatched. Orders for stocked parts will be available for despatch within 60 minutes of order acceptance by ASP, and transport arrangements from our part of Brisbane to all Australian towns, are excellent.

We use StarTrack, Post, TNT & TGE for deliveries unless otherwise directed, please allow 2-7 days to QLD and NSW, 4-9 days to VIC, NT and SA, and 5-12 days to WA and TAS (subject to change).

3 month Replacement Parts Warranty

All ASP's replacement parts carry a warranty against defects in material and workmanship for 3 months from date of purchase. This warranty is subject to normal wear and tear.

Product Liability Insurance

ASP's Public/Product Liability Insurance policy is maintained with reputable insurers to provide Public/Product indemnity of \$20 million.

Disclaimer

Any reference to Original Equipment Manufacturers, ASP competitors, and their part numbers are for reference only. All parts listed are supplied to fit machines indicated and are not sold as genuine.

IMPORTANT

The information and specifications given in this catalogue is given in good faith as being correct and an accurate guide to ordering and correct part identification. Customers are nevertheless encouraged to thoroughly check for part number correctness before ordering, by verifying sizes, and models fitted, and OEM cross references to ensure any part ordered is correct for your application. ASP reserve the right to upgrade specifications without prior notice.

© Alloy & Stainless Products Pty Ltd 2003. All rights reserved. No data, information, images etc in this catalogue may be copied, produced, stored on a retrieval system, or transmitted in any form or by any means, without the prior written consent of Alloy & Stainless Products Pty Ltd. "ASP", "ASP Components" and "Lightning" are registered Trade Marks of Alloy & Stainless Products Pty Ltd.



PH: 07 3881 3464

FX: 07 3881 3474

WEB: www.asproducts.com.au

Email: sales@asproducts.com.au

PO Box 3175 Clontarf DC Qld 4019,
359 MacDonnell Rd Clontarf Qld 4019

Ph: 07 3881 3464

Email: sales@asproducts.com.au

www.asproducts.com.au

ABN: 91 088 139 520



ASP
Components TM



In association with our 27 year partnership with La Pina, ASP supply an array of wear resistant products that are manufactured to World Class Standards.

Production of parts incorporates the latest technological advantages in Boron Steel processing. Boron steel is used to provide our customers with superior wear resistant characteristics and excellent value for money! ASP distribute our parts Australia wide and provide fast delivery coupled with great customer service.